

Laser Methane mini
SA3C32A

LaserMethane **mini**

Operation Manual

Read this manual before using the equipment.

Keep this manual with the equipment.



Tokyo Gas Engineering Solutions Corporation

For Safety





Prior to using this product, please read the “For Safety” section to ensure safe and appropriate usage

- In this operation manual and product labels, the methods for safely using this product, methods for avoiding danger by users and others, and various cautions are indicated by picture symbols.
- The degree of danger, potential harm, and urgency in case of incorrect operation are indicated by DANGER, WARNING, and CAUTION. Each of these indications denotes important safety-related items. Be sure to observe these items. The symbols and their meanings are as follows.

Degree of Injury/Damage and Corresponding Safety Symbol

 DANGER	This indicates dangerous contents that are very likely to result in serious injury or death for the user if this symbol is ignored, and operation is not performed properly.
 WARNING	This indicates contents that could result in serious injury or death for the user if this symbol is ignored, and operation is not performed properly.
 CAUTION	This indicates contents that could result in injury for the user or physical damage of the product if this symbol is ignored, and operation is not performed properly.

Safety Symbols Used on This Product and in This Manual

	This indicates a prohibited operation. The prohibited operation is indicated symbolically in or near the barred circle.
	This indicates an obligatory safety precaution. The obligatory operation is indicated symbolically in or near the circle.
	This indicates warning or caution. The contents are indicated symbolically in or near the triangle.
	This indicates a note. The contents are described in the box.
	This indicates that the marked part should be recycled.

For Safety

SA3C32A
LaserMethane mini
Operation Manual

10 September 2015 (First Edition)

All rights reserved. No part of this manual may be reproduced without the prior written permission of the publisher.

The contents of this manual may be changed without prior notice.

Copyright© 2015, Tokyo Gas Engineering Solutions Corporation

Printed in Japan

For Safety

 **DANGER**

-
- ⊗ Do not use this product in case of an anomaly such as smoke or strange smell. Continuing to use the product under such conditions may cause fire or electric shock. In case of an anomaly, immediately take the **Actions** indicated below.

 - ⊗ Do not use the product if its' outer body (case) is broken, as this may cause fire or electric shock. Immediately take the **Actions** indicated below.

 - ⊗ Do not use the product if water or foreign objects have gotten inside. Continuing to use the product under such conditions may cause fire or electric shock. Immediately take the **Actions** indicated below.

[Actions]

- Switch off the power of the product.
 - Remove the battery pack from the main unit.
 - Disconnect the power plug of the battery charger from the power outlet.
 - Contact Customer Service.
-

For Safety

 **DANGER**

⊗ **Incorrect handling of the battery pack may cause fire, electric shock, or an explosion. Be sure to observe the following points.**

- Do not use a battery pack other than the dedicated battery pack for this product.
 - When inserting the battery pack in the main unit (or battery charger), do so by observing the specified directions.
 - Do not charge the battery pack with a method other than that described in the Operation Manual.
 - Do not store or carry the battery pack together with metal objects such as coins, keys, or chain.
 - Do not dismantle, damage, or heat the outer body (chassis) of the battery pack.
 - Do not throw the battery pack into fire.
 - Do not use, store, or discard the battery pack in a place with high temperature (near a fire, a place exposed to direct sunlight, in a car under the blazing sun, etc.).
 - Do not expose the battery pack to water, oil, or other liquids, and do not use it in locations with high humidity.
 - Do not use the battery pack when it leaks.
 - When not using the product for a long time, remove the battery pack from the main unit.
-

For Safety

WARNING

Do not disassemble the main unit.

This may cause electric shock leading to death, burns, or injury. For internal inspections, adjustments, or repairs, be sure to contact Customer Service.

Incorrect use of the battery charger may cause fire or electric shock.

Be sure to observe the following points.

- Do not expose the battery charger to water, oil, or other liquids, and do not use it in locations with high humidity.
 - Do not use the battery charger while its outer body (chassis) is broken.
 - Do not use a damaged AC cord (exposed wires, broken wires, etc.)
 - Do not damage the AC cord, break it, process it, bend it forcefully, pull on it, twist it, roll it up, cover it with heavy objects, fix it with nails or wire, or heat it up.
 - Do not connect the AC cord to a multi-outlet such as a cable tap or a current tap socket.
 - When inserting the power plug of the AC cord to a power outlet or the battery charger, be sure to insert it securely.
-

Do not look at the laser light or direct it toward people while the product is powered, as this may cause harmful exposure and injury.

Be sure to observe the following points.

- Do not cast laser light directly into the eyes.
 - Absolutely never look directly into the laser light.
 - Do not let children handle the product.
-

Never charge the battery pack in locations where may contain explosive gas.

The battery charger does not feature an intrinsically safe design.

For Safety

 **CAUTION**

- ⊘ Do not subject the main unit, battery charger, and battery pack to strong shocks or vibrations, because this may cause failure.

 - ⊘ Do not forcefully push the display or subject it to strong shocks, because this may cause the display screen to break.

 - ⊘ Do not use the product and battery charger in locations where heat builds up, because this may cause fire. Be sure to observe the following points.
 - Do not charge the unit on soft furnishings (cushions, bedding, furniture etc).
 - Do not cover the product and battery charger with a tablecloth, etc.
 - Do not use the product and battery charger in a location with poor air circulation such as inside a box.
-

For Safety

CAUTION

⊗ **Improper use of the battery charger may cause fire or electric shock.**

Be sure to observe the following points.

- If lightning occurs nearby, remove the power plug of the AC adapter from the power outlet and do not use it until the lightning stops.
- Once charging of the battery pack has been completed, remove the battery pack from the battery charger.
- When removing the power plug of the AC adapter from the power outlet or the battery charger, be sure to grasp the power plug instead of the AC cord.
- Do not let the AC cord near thermal appliances.

⊗ **The battery pack becomes hot during charging. Be careful when handling it.**

⊗ **Do not keep looking at the detection lamp for a long time. This may cause dazzling, which can possibly cause a secondary accident.**

In case the detection lamp is unnecessary, this function can be disabled by changing the setting. (See 6. Detection Lamp of 5.3 Changing Settings)

⊗ **If you store the main unit with the battery pack installed for more than two months, the battery in the battery pack will be over-discharged and become unusable.**

⊗ **Do not use over-discharged battery because it is not safe. Buy a new battery pack.**

Regularly charge the battery pack once a month.

When using this product, be careful with electrostatic discharge.

It is necessary for this product to restart because of the electrostatic discharge.

For Safety

CAUTION

When using the product, be sure to use the strap.

Breakage, failure, and foot injury caused by a dropping of the product can be prevented by using the strap.

-
- Accurate gas measurement may not be possible in the vicinity of other electric devices or industrial equipment that produces electrical noise. In this case, perform gas measurement with the product a little farther away.

-
- Do not use the product in locations where hydrogen sulfide occurs (such as hot springs), or locations with a lot of salt (such as the seacoast), because this may shorten the life of the product.

When storing the product, be sure to observe the following points.

- Do not store the product in extremely hot locations such as inside a car, or in cold locations directly exposed to outside air.
- Avoid storing the product in locations where it can be exposed to strong vibrations.
- Storing the battery pack in high temperatures may shorten its life, so store it at 30°C or lower.

-
- When transporting the main unit and battery charger, be sure to observe the following points.

- When transporting the main unit and battery charger in a car, etc., be sure to protect the product from direct vibrations and shocks.
- When shipping the main unit, battery pack, or battery charger for repair, etc., place shock absorbing material in the shipping box.

-
- Do not direct the guide laser light at the strong light such as the sunlight for a long time. It may damage inside of the product.

-
-  Do not peel off the security labels on the product. Warranty shall become void by any tampering with the security labels.



For Safety



Laser Safety

The Measurement light beam radiation in this product is classified as Class 1 according to the IEC 60825-1 specifications.

The guide light beam radiation is classified as Class 3R according to the IEC 60825-1 specifications.

Classes are indicated on the label attached to the top of the product (Refer to “Laser Radiation Markings”).

Do not look into the laser guide light directly, because the laser radiation might harm your eyes. Do not use towards other people while the product is powered. The output of the laser guide light can be confirmed with an indication of [LASER] on the display.

Class 1 and 3R indicate the danger degree of the laser beam specified below according to IEC 60825-1.

Class 1: Laser radiation that is safe under reasonably foreseeable conditions of operation, including the use of optical instruments for intrabeam viewing.

Class3R: Lasers that emit in the wavelength range from 302,5 nm to 106 nm where direct intrabeam viewing is potentially hazardous but the risk is lower than for Class 3B lasers, and fewer manufacturing requirements and control measures for the user apply than for Class 3B lasers. The accessible emission limit is within five times the AEL (Accessible Emission Limit) of Class 2 in the wavelength range from 400 nm to 700 nm and within five times the AEL of Class 1 for other wavelengths.

For Safety

Laser Radiation Markings



⚠ LASER RADIATION AVOID DIRECT EYE EXPOSURE

MAX OUTPUT POWER	PULSE DURATION/PULSE PERIOD	WAVELENGTH
5mW	CW 100ms/200ms	520nm

IEC 60825-1:2007
CLASS 3R LASER PRODUCT

⚠ DANGER
Do NOT charge the SA0Z40A Battery Pack in explosive atmospheres. ☑ N274

Contains FCC ID: E90001ZEAL-C02
Contains IC: 10171A-001ZEALC02

SA3C32A LaserMethane mini

CE 0344 KEMA 08ATEX0005 Ta: -17 to +50°C

CERTIFICATION LABEL

THIS PRODUCT COMPLIES WITH 21 CFR 1040.10 AND 1040.11 EXCEPT FOR DEVIATIONS PURSUANT TO LASER NOTICE NO. 50, DATED JUNE 24, 2007

IDENTIFICATION LABEL

ANRITSU CORPORATION.
5-1-1, Onna, Atsugi-shi, Kanagawa 243-8555, Japan
MANUFACTURED AT: TOHOKU ANRITSU CO., LTD.
KORIYAMA PLANT, APRIL, 2015

MADE IN JAPAN 生产日期 2015-04
SN: 0000000000

Specification concerning laser radiation

1. Laser Safety Classifications Based on IEC 60825-1:2007

■ Measurement light beam radiation (Class 1 Laser)

- Maximum output power : 10mW or less
- Pulse width : CW
- Wavelength : 1653nm
- Beam extension in collimated beam : 8.5mrad or less

■ Guide light beam radiation (Class 3R Laser)

- Maximum output power : 5mW or less
- Pulse width / Pulse period : CW, 100ms/200ms
- Wavelength : 520nm
- Beam extension in collimated beam : 1.5mrad or less

2. Incorporated Laser Specification

■ Measurement light beam radiation

- Pulse width : CW
- Wavelength : 1653nm
- Beam extension in collimated beam : 8.5mrad or less
- Embedded laser output level : 60mW or less

■ Guide light beam radiation

- Pulse width / Pulse period : CW, 100ms/200ms
- Wavelength : 520nm
- Beam extension in collimated beam : 1.5mrad or less
- Embedded laser output level : 5mW or less

⚠ CAUTION

Use of controls or adjustments or performance of procedures other than those specified herein may result in hazardous radiation exposure.

For Safety

WARNING

Employment of an Explosion-Protected Equipment

If the customer conducts repair or modification to an intrinsically safe or explosionproof equipment and the equipment is not restored to its original condition, its intrinsically safe or explosionproof construction may be compromised and the equipment may be hazardous to operate. Please contact Customer Service before making any repair or modifications to an equipment.

CAUTION

This equipment, including SA0Z40A Battery Pack, has been tested and certified as being intrinsically safe or explosionproof. Please note that severe restrictions apply to this equipment's construction, maintenance and repair. A failure to abide by these restrictions could make equipment hazardous to operate.

WARNING

DO NOT disassemble this equipment. Disassembling it is strictly prohibited in order to maintain the safety level of an explosionproof equipment. This equipment cannot be repaired by the user.

For Safety

 **DANGER**

DO NOT use this equipment at explosive atmospheres except the approved category.

Using this equipment at the *Zone 0* for city gas, etc. is strictly prohibited.

 **DANGER**

DO NOT charge the battery pack in explosive atmospheres. The battery charger is not an explosionproof equipment.

For Safety

CENELEC ATEX (KEMA) Intrinsically Safe Type

Caution for CENELEC ATEX (KEMA) Intrinsically Safe Type.

Note 1. Intrinsically Safe Type

- ATEX intrinsically Safe Type : Type "i"
- Certificate Number : KEMA 08ATEX0005
- Product : SA3C32A Laser Methane mini
- Manufacturer : ANRITSU CORPORATION
- Address : 5-1-1 Onna, Atsugi-shi, Kanagawa, 243-8555 Japan
- Applicable Standard : EN 60079-0:2012, EN 60079-11:2012, EN60079-28:2007
- Type of Protection and Marking code

: (E) 0344  I M2
II 2G Ex ib op-pr/op-is I
IIA T1

- Group :I and II
- Category : M2 and 2G
- Ambient Temperature : -17 to +50 °C
- Applicable detection hazardous areas:
 - Zones 1 and 2 for city gas, etc.
 - Zone 1 for coal mines

Note 2. Battery

- Ensure using only the following battery.
SA0Z40A Battery Pack

Note 3. Maintenance and Repair

- Disassembling and modifying this equipment, including SA0Z40A Battery Pack, by other than authorized representative of Anritsu Corporation is prohibited and will void KEMA Intrinsically safe Certification.

For Safety



WARNING



Thank you for cooperating with recycling of the nickel-hydride battery.

This product uses a nickel-hydride battery pack. This battery pack includes rare materials such as nickel oxide and hydrogen storage alloys that can be recycled as precious resources. After implementing the safety measures listed below for the used battery pack, contact Customer Service.



For the sake of safety, recycle the battery packs that are no longer used after discharging them in procedures as follows.

- Insert the battery pack in the main unit.
 - Switch on the power of the main unit.
 - Until the empty screen is indicated, leave the main unit (indicating that the battery pack is discharged).
 - Remove the battery pack from the main unit.
 - Tape insulating tape such as vinyl tape on the contact part of the battery pack (to prevent short-circuit accidents caused by the residual electricity in the battery pack).
 - Contact Customer Service and ask for instructions regarding the recycling method.
-

For Safety

Bluetooth Communication Function

This function is available only Bluetooth model.

- If either this product or the Android device is placed in a metal case, connection may not be established. After connection is established, if this product or the Android device is placed in a metal case, communication may be disconnected, communication distance become shorter, or each of the devices cannot communicate correctly. Please use this product and the Android device without putting in a metal case.

- If the Bluetooth function of this product is used near the equipment with the wireless LAN (IEEE802.11b/g), the communication speed of wireless LAN may be degraded. In addition, communication speed between this product and the *Android* device may also be degraded, or the communication may be disconnected. So in this case, turn off the wireless LAN or please use this product and the Android device away from the equipment with the wireless LAN.

- The communication distance between this product and the Android device is approximately 10 m. However, it is increased or decreased by the environment of usage or radio wave conditions.

- △ The radio wave of 2.4 GHz band used as Bluetooth communication may affect the medical electronic devices. When this product is used at the place that there is medical electronic devices, be careful about the effect to the medical electronic devices.

- △ If the divulging of measurement data or information is happened, Tokyo Gas Engineering Solutions Corporation shall not be liable.

Warranty

Tokyo Gas Engineering Solutions Corporation offers a 12-month warranty from date of purchase and provides free repair of any faults arising from manufacturing defects. However, the following cases are not covered by the warranty.

- Faults that do not fall within the scope of the warranty listed in the Operation Manual
- Faults caused by improper operation, use, unauthorized modifications, dismantling, or repairs on the part of the customer
- Faults caused by heavy use that clearly exceeds normal use
- Faults caused by improper or insufficient maintenance on the part of the customer
- Unavoidable faults arising from fires, floods, earthquakes, other acts of God, etc.
- Faults caused by connecting any other products, parts, or consumables other than the specified ones
- Faults caused by a power supply, usage location, etc., other than the specified ones

Among damages that arise from defects in this product, Tokyo Gas Engineering Solutions Corporation shall not be liable for damages and loss of business of the customer that arise from unforeseeable and special circumstances.

Inquiries to Tokyo Gas Engineering Solutions Corporation

In the case of faults in the product, promptly contact Customer Service listed at the end of this manual.

Electromagnetic Interference

This product complies with the EC Directive on CE Marking and is targeted for use in industrial environments.

Note, however, that if this product is used near a radio or television receiver, reception interference may occur. Also note that the product may be unable to detect gas properly if used near an electrical product or industrial product that generates a strong magnetic field or electrical noise.

Notes In Regard To Use

Ensure the following points.

- Upon handling this product, please take sufficient precautions against static electricity. Please use this product in an environment where sufficient measures are implemented against static electricity.
- This product is an intrinsically safe product. Please use this product in an environment which confirms to the intrinsically safety standards of this product.

Crossed-out Wheeled Bin Symbol

Equipment marked with the Crossed-out Wheeled Bin Symbol complies with the Council Directive 2002/96/EC (the “WEEE Directive”) in the European Union.



For products develop in the EU market after August 13, 2005, please contact **Tokyo Gas Engineering Solutions Corporation** at the end of the product’s useful life to arrange disposal in accordance with your initial contract and local law.

Radio law certification

This product is certified by the radio law of Japan, United States, and Canada only. If you use this product in other countries requiring certification, contact Customer Service or your local sales agent.

Trademark acknowledgments

Android is owned by the Google Inc.

Google and Google Maps are owned by the Google Inc.

The Bluetooth logo is owned by the Bluetooth SIG, Inc. and any use of such marks by Tokyo Gas Engineering Solutions Corporation is under license.

Other trademarks and trade names are those of their respective owners.

TM or [®] mark is not specified in this operation manual.

CE Conformity marking

Tokyo Gas Engineering Solutions Corporation affixes the CE Conformity marking on the following product (s) in accordance with the Council Directive 93/68/EEC to indicate that they conform to the EMC, ATEX and R&TTE Directive of the European Union (EU).



1. Product Model

Model: SA3C32A LaserMethane mini
and

Accessories: SA0Z40A BATTERY PACK
SA0Z41A PROTECT COVER
SA0Z42A BATTERY CHARGER
SA0Z47C AC ADAPTER SET (EU)
SA0Z44B STRAP (Long type)
SA0Z60A CARRYING CASE

2. Applied Directive

EMC: Council Directive 2004/108/EC
ATEX: Council Directive 94/9/EC
R&TTE: Council Directive 1999/5/EC

3. Applied Standards

EMC: Emission: EN61326-1: 2013

Immunity: EN61326-1: 2013

	SA3C32A	SA0Z42A	Performance Criteria*
IEC61000-4-2 (ESD)	-	√	B
IEC61000-4-3 (EMF)	√	√	A
IEC61000-4-4 (Burst)	-	-	B
IEC61000-4-5 (Surge)	-	-	B
IEC61000-4-6 (CRF)	-	-	A
IEC61000-4-8 (RPFMF)	-	-	A
IEC61000-4-11 (V dip/short)	-	-	C

***: Performance Criteria**

A: The equipment shall continue to operate as intended during and after the test. No degradation of performance or loss of function is allowed below a performance level specified by the manufacturer, when the equipment is used as intended. The performance level may be replaced by a permissible loss of performance. If the minimum performance level or the permissible performance loss is not specified by the manufacturer, either of these may be derived from the product description and documentation and what the user may reasonably expect from the equipment if used as intended.

B: The equipment shall continue to operate as intended after the test. No degradation of performance or loss of function is allowed below a performance level specified by the manufacturer, when the equipment is used as intended. The performance level may be replaced by a permissible loss of performance. During the test, degradation of performance is however allowed. No change of actual operating state or stored data is allowed. If the minimum performance level or the permissible performance loss is not specified by the manufacturer, either of these may be derived from the product description and documentation and what the user may reasonably expect from the equipment if used as intended.

C: Temporary loss of function is allowed, provided the function is self-recoverable or can be restored by the operation of the controls.

The power consumption of the AC ADAPTER is 29.70W, which is less than 75W and no limits apply. Therefore it is deemed to comply with EN61000-3-2 without any testing.

ATEX: EN60079-0: 2012
EN60079-11: 2012
EN60079-28: 2007

R&TTE: HEALTH & SAFETY (Article 3.1(a):
EN60950-1:2006 +A11:2009 +A1:2010 +A12:2011 *)
EN62479:2010 *)

EMC (Article 3.1(b):
EN 301 489-1 V1.9.2 (2011-09)
EN 301 489-17 V2.2.1 (2012-09)

SPECTRUM (Article 3.2)
EN 300 328 V1.8.1 (2012-06) *)

*) These standards are applied to the radio modem only.

C-tick Conformity marking

Tokyo Gas Engineering Solutions Corporation affixes the C-tick marking on the following product (s) in accordance with the regulation to indicate that they conform to the EMC framework of Australia/New Zealand.

C-tick marking



1. Product Model

Model: SA3C32A LaserMethane mini
and

Accessories: SA0Z40A BATTERY PACK
SA0Z41A PROTECT COVER
SA0Z42A BATTERY CHARGER
SA0Z47C AC ADAPTER SET (EU)
SA0Z44B STRAP (Long type)
SA0Z60A CARRYING CASE

2. Applied Standards

EMC: Emission:
AS/NZS 2064.1/2
(ISM, Group 1, Class A equipment)

FCC Regulations

This equipment has been tested and found to comply with the limits for a Class B digital device, pursuant to part 15 of the FCC Rules. These limits are designed to provide reasonable protection against harmful interference in a residential installation. This equipment generates, uses and can radiate radio frequency energy and, if not installed and used in accordance with the instructions, may cause harmful interference to radio communications. However, there is no guarantee that interference will not occur in a particular installation. If this equipment does cause harmful interference to radio or television reception, which can be determined by turning the equipment off and on, the user is encouraged to try to correct the interference by one or more of the following measures:

- Reorient or relocate the receiving antenna.
- Increase the separation between the equipment and receiver.
- Connect the equipment into an outlet on a circuit different from that to which the receiver is connected.
- Consult the dealer or an experienced radio/TV technician for help.

Changes or modifications not expressly approved by the party responsible for compliance could void the user's authority to operate the equipment.

This transmitter must not be co-located or operated in conjunction with any other antenna or transmitter.

RF Exposure Compliance

This equipment complies with FCC radiation exposure limits set forth for an uncontrolled environment and meets the FCC radio frequency (RF) Exposure Guidelines in Supplement C to OET65. This equipment has very low levels of RF energy that it deemed to comply without maximum permissive exposure evaluation (MPE). But it is desirable that it should be installed and operated keeping the radiator at least 20cm or more away from person's body (excluding extremities: hands, wrists, feet and ankles).

IC Regulations

This device complies with Industry Canada licence-exempt RSS standard(s).

Operation is subject to the following two conditions:

- (1) this device may not cause interference, and
- (2) this device must accept any interference, including interference that may cause undesired operation of the device.

Le présent appareil est conforme aux CNR d'Industrie Canada applicables aux appareils radio exempts de licence.

L'exploitation est autorisée aux deux conditions suivantes :

- (1) l'appareil ne doit pas produire de brouillage, et
- (2) l'utilisateur de l'appareil doit accepter tout brouillage radioélectrique subi, même si le brouillage est susceptible d'en compromettre le fonctionnement.

RF Exposure Compliance

This equipment complies with IC radiation exposure limits set forth for an uncontrolled environment and meets RSS-102 of the IC radio frequency (RF) Exposure rules. This equipment has very low levels of RF energy that it deemed to comply without maximum permissive exposure evaluation (MPE). But it is desirable that it should be installed and operated keeping the radiator at least 20cm or more away from person's body (excluding extremities: hands, wrists, feet and ankles).

Cet équipement est conforme aux limites d'exposition aux rayonnements énoncées pour un environnement non contrôlé et respecte les règles d'exposition aux fréquences radioélectriques (RF) CNR-102 de l'IC. Cet équipement émet une énergie RF très faible qui est considérée conforme sans évaluation de l'exposition maximale autorisée. Cependant, cet équipement doit être installé et utilisé en gardant une distance de 20 cm ou plus entre le dispositif rayonnant et le corps (à l'exception des extrémités : mains, poignets, pieds et chevilles).

FCC/IC ID Drawing



[Back side]

LASER RADIATION AVOID DIRECT EYE EXPOSURE		
MAX OUTPUT POWER 5mW	PULSE DURATION/PULSE PERIOD CW 100ms/200ms	WAVELENGTH 520nm
IEC 60825-1:2007 CLASS 3R LASER PRODUCT		

⚠ DANGER
Do NOT charge the SA0Z40A Battery Pack in explosive atmospheres. ✓ N274

Contains FCC ID: E90001ZEAL-C02
Contains IC: 10171A-001ZEALC02

SA3C32A LaserMethane mini

CE 0344 Ex IM2 II2G Ex ib op-pr/op-is I IA T1
KEMA 08ATEX0005 Ta: -17 to +50°C

CERTIFICATION LABEL
THIS PRODUCT COMPLIES WITH 21 CFR 1040.10 AND 1040.11 EXCEPT FOR DEVIATIONS PURSUANT TO LASER NOTICE NO. 50, DATED JUNE 24, 2007

IDENTIFICATION LABEL
ANRITSU CORPORATION.
5-1-1, Onna, Atsugi-shi, Kanagawa 243-8555, Japan
MANUFACTURED AT: TOHOKU ANRITSU CO., LTD.
KORIYAMA PLANT, APRIL, 2015
MADE IN JAPAN

生产日期 2015-04
SN : 0000000000

KC 등록정보

본제품은 아래와 같이 등록되어 있습니다.

KC marking



- 등록번호 : KCC-RMM-A2J-AD0001
- 신청자명 : 안리츠주식회사
- 제품명 : LaserMethane mini
- 모델명 : SA3C32A LaserMethane mini
- 제조년월 : 본체라벨에 기재
- 제조자명 : 안리츠주식회사
- 제조국 : 일본

위험

해당 무선설비는 전파혼신 가능성이 있으므로 인명안전과 관련된 서비스는 할 수 없습니다

주의

A 급 기기 (업무용 방송통신기자재)

이 기기는 업무용(A 급) 전자파적합기기로서 판매자 또는 사용자는 이 점을 주의하시기 바라며, 가정외의 지역에서 사용하는 것을 목적으로 합니다.

The following are the provisions of “Measures for Administration of the Pollution Control of Electronic Information Product” of the People’s Republic of China.

They are applicable only in the People’s Republic of China.

关于符合中国《电子信息产品污染控制管理办法》的声明

产品中有毒有害物质或元素的名称及含量

部件名称	有毒有害物质或元素					
	铅 (Pb)	汞 (Hg)	镉 (Cd)	六价铬 [Cr(VI)]	多溴联苯 (PBB)	多溴二苯醚 (PBDE)
印刷线路板 (PCA)	×	○	×	×	○	○
机壳、支架 (Chassis)	×	○	×	×	○	○
其他(电缆、风扇、 连接器等) (Appended goods)	×	○	×	×	○	○

○：表示该有毒有害物质在该部件所有均质材料中的含量均在 SJ/T 11363-2006 标准规定的限量要求以下。

×：表示该有毒有害物质至少在该部件的某一均质材料中的含量超出 SJ/T 11363-2006 标准规定的限量要求。

环保使用期限



这个标记是根据 2006/2/28 公布的「电子信息产品污染控制管理办法」以及 SJ/T 11364-2006「电子信息产品污染控制标识要求」的规定，适用于在中国销售的电子信息产品的环保使用期限。仅限于在遵守该产品的安全规范及使用注意事项的基础上，从生产日起算的该年限内，不会因产品所含有害物质的泄漏或突发性变异，而对环境污染，人身及财产产生深刻的影响。

注) 电池的环保使用期限是 5 年。

About This Manual

This operation manual describes how to use and maintain the SA3C32A LaserMethane mini (hereinafter, this product). Chapter 1 describes “Outline and Principle” and the following sections provide more detailed explanations.

Table of Contents

1. Outline and Principle	1
1.1 Outline	1
1.2 Principle	2
2. Introduction	3
2.1 Checking Package Contents	3
3. Nomenclature	4
3.1 Main unit	4
3.2 Display	5
4. Preparations Before Use	6
4.1 Charging Battery Pack	6
4.2 Attaching Strap	8
4.3 Attaching Battery Pack	9
5. Operation Method	10
5.1 Starting Up and Ending	10
5.2 Measurement	12
5.3 Changing Settings	15
5.4 Automatic Calibration	24
5.5 Indicating Residual Power of Battery Pack	25

5.6 Gas test by customer	26
5.7 Connect this product with Android device	29
6. Error Messages	28
6.1 Explanation of Errors and Measures	28
7. IN CASE OF TROUBLE.....	31
7.1 Problems and Solutions	31
8. Daily Maintenance.....	33
8.1 Maintenance Method	33
9. Main Specifications	34
9.1 Main Specifications of Main Unit	34
9.2 Main Specifications of Battery Charger and AC Adapter	36
10. Ordering Information	37
10.1 Main Unit and Standard Accessories	37
11. Inquiries	38
11.1 Customer Service	38
12. Distributor and Manufacture	39
12.1 Distributor	39
12.2 Manufacture	39

1. Outline and Principle

1.1 Outline

This product is a handheld gas detector for remote detection of methane and methane-containing gases (natural gas or similar). Gas leakage and accumulation within approximately 30 meters can be detected quickly by directing a laser beam at the area to be inspected.

The measuring point is illuminated by a green guide light clearly visible, and then the measured value of methane is displayed on the display in real time.

With this product, after connecting to the Android phone or tablet device (hereinafter, Android device) with the Bluetooth, you can transfer measured data to the Android device. On the Android device, data storage and graphical display are possible with dedicated application software. Moreover, working with the GPS (Global Positioning System) function mounted on the Android device, measurement and location data can be displayed on the Google Maps.

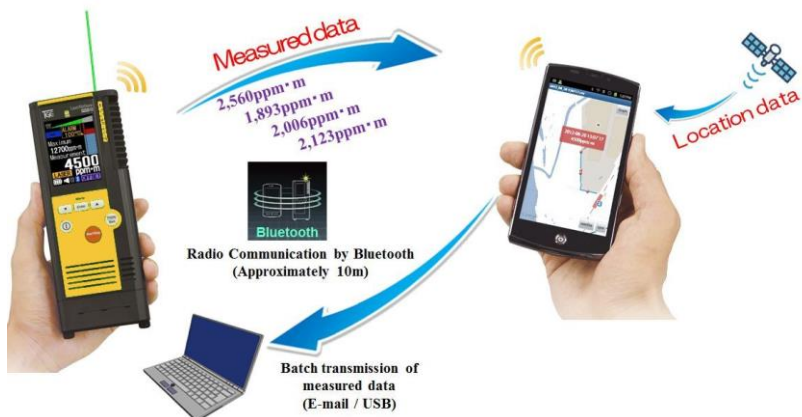

1.2 Principle

This product is based on Infrared Absorption Spectroscopy using a semiconductor laser for methane detection. The integrated concentration of methane between this product and the target point is measured by transmitting a detection laser beam towards the target point (gas piping, ceiling, wall, floor, ground, etc.) then detecting a fraction of the diffusely reflected beam from that target point. The measured value is expressed by a methane column density (ppm·m): the methane concentration (ppm) multiplied by the thickness (m).

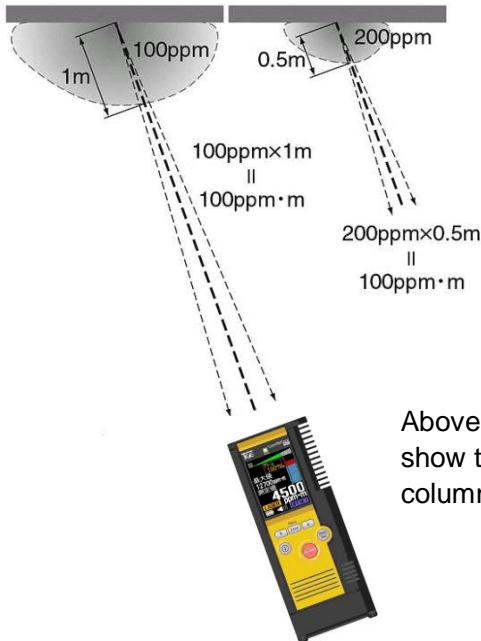

In addition, this product does not respond in principle to gases other than methane (butane, propane, etc.). This product cannot perform detection in places where detection laser beam cannot reach, such as the opposite side of a wall or underground.

2. Introduction

2.1 Checking Package Contents

Remove the main unit and the supplied accessories from the package and make sure that you have received all the items listed below. If there are any missing or damaged items, immediately contact Customer Service.

Main unit

Main unit: 1 unit



Battery pack: 1 pc.



Standard Accessories

Battery charger: 1 unit



AC adapter: 1 unit

(AC cord: 1 pc.)



Strap: 1 pc.



Protect cover: 1 pc.



Carrying case: 1 pc.



Operation manual: 1 vol.



3. Nomenclature

3.1 Main unit

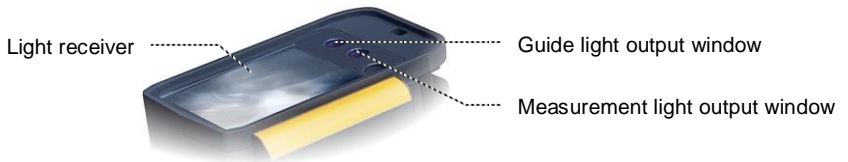
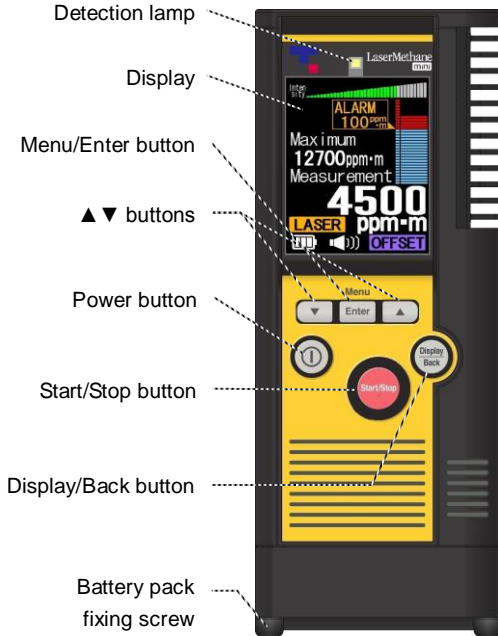

3.2 Display

Numeric Mode

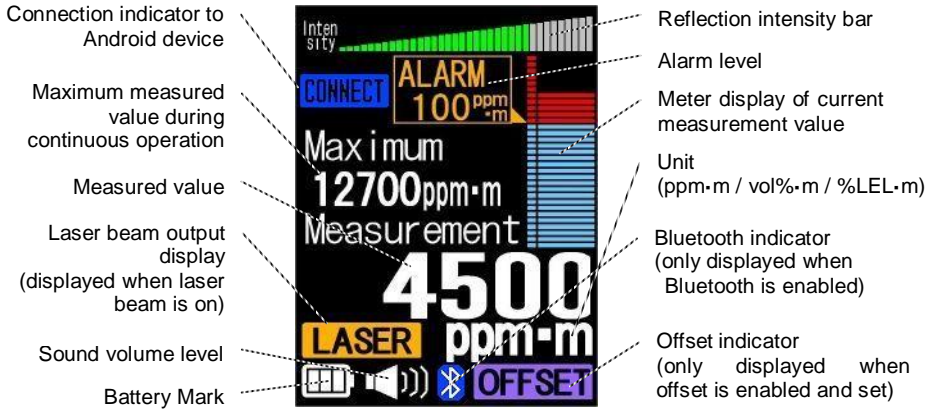

Graph Mode

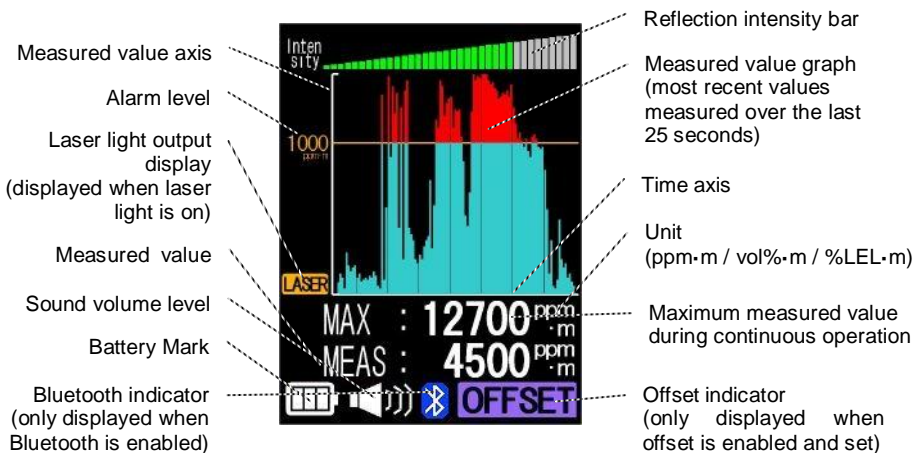

- ❖ When the remaining battery level is shown in the figure on the right, the power will switch off in approx.15 min. If this symbol appears, recharge the battery pack. (See “4.1 Charging Battery Pack”)



4. Preparations Before Use

4.1 Charging Battery Pack

Charging Method

1. Connect the battery charger, AC adapter, AC cord, and power outlet in the sequence shown below, (1-2-3).

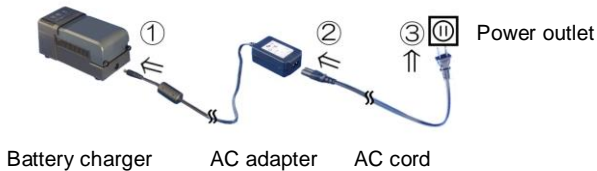

2. Attach the battery pack so that the corner of the battery pack coincides with the Δ mark on the battery charger (slide the battery pack securely all the way to the end).



- ❖ Explanation of LED display of battery charger
 - The orange LED, when lit, indicates that charging is in progress.
 - The green LED, when lit, indicates that charging has been completed.
 - The red LED, when lit, indicates an anomaly.

DANGER

When the red LED of the battery charger lights up, immediately disconnect the power plug of the battery charger from the power outlet, remove the battery pack from the battery charger, and contact Customer Service.

4. Preparations Before Use

3. When charging is completed, remove the battery pack from the battery charger by sliding it out.



- ❖ Disconnect the power plug of the battery charger from the power outlet after charging is completed.

CAUTION

The battery pack and the battery charger may become hot during charging.

WARNING

Use the dedicated battery pack (SA0Z40A) only with the dedicated battery charger (SA0Z42A).

Do not use an AC adapter such as a car charger other than the dedicated one (SA0Z43A).

WARNING

Never charge the battery pack in a location with flammable gas.

WARNING

The battery charger does not feature an intrinsically safe design.

Replacement Schedule

The battery pack has a service life of approximately 500 cycles*. If the operating time of the product becomes extremely short even though it has been fully charged, this indicates that the battery pack has reached the end of its service life. Replace the battery pack with a new one.

* This figure is a guideline based on JIS C8708 test conditions. (The actual number of cycles may differ according to the product and the usage conditions.)

4.2 Attaching Strap

Attach the strap

See the figure on the right.



CAUTION

To prevent breaking of the product due to dropping, be sure to use it with your hand through the strap.

4.3 Attaching Battery Pack

Attaching the battery pack to the main unit

1. Attach the battery pack so that the corner of the battery pack coincides with the Δ mark on the main unit.
2. Tighten the two battery pack fixing screws at the base of the battery pack.



Removing the battery pack

1. Loosen the two battery pack fixing screws at the base of the battery pack.
2. Remove the battery pack by pulling it sideways to the Δ mark on the main unit and then pull it up.



CAUTION

Two months or more, when you do not use it, please remove a battery pack from a main unit. If a battery pack is kept while connecting with a main unit two months or more, there is a case where a battery pack serves as fault electric discharge, and it becomes impossible to use it.

5. Operation Method

5.1 Starting Up and Ending

Switching on the power

1. Press the Power button for approximately 2 seconds. (The product will emit a beeping sound.)



2. The startup screen appears for a few seconds, followed by the self-test screen, which is also displayed for a few seconds.

- ❖ The startup time may be longer depending on the temperature.
- ❖ The self-test is a self-diagnostic test for accurate measurement.
- ❖ After the startup and self-test, if you set the “1. Enable” in the “8. Gas test” on the [SETTINGS]

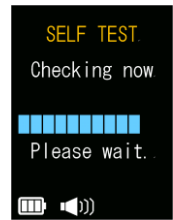

- screen, the proceeding screen for the gas test to be performed by the customer will be displayed.
- (See “5.6 Gas test by customer” for details about the gas test.)

3. Once the measurement preparations have been completed, the numeric mode screen shown on the right is displayed, and the product becomes stand-by state of measurement.

- ❖ The screen can be switched to the graph mode by pressing the Display/Back button.

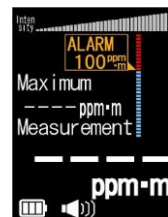

Numeric mode

Switching off the power

1. Press the Power button for approximately 2 seconds. (The product will emit a beeping sound.)
2. The screen will switch off.



5.2 Measurement

1. Press the Start/Stop button (red button at the center) and direct the guide light toward the area to be measured.



- ❖ When the measurement is started, the guide light turns on. If you press the Enter button, you can switch the guide light to flash.
2. The measured value is displayed as shown in the screen on the right.

- ❖ If the measured value is displayed in white, the measurement was done accurately.

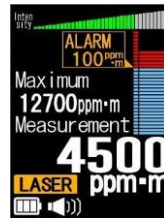

Numeric mode

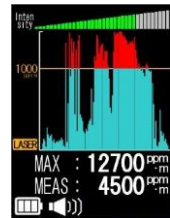

Graph mode

- ❖ If the measured value is displayed in gray, it is a reference value (this is a value with low measurement accuracy due to insufficient received light intensity).
- ❖ To toggle the screen, press the Display/Back button.
(Numeric mode ↔ Graph mode)

3. To end measurement, press the Start/Stop button again.
 - ❖ During measurement, the measured and maximum values are displayed every 0.5 seconds, and when measurement ends, the data is kept.
 - ❖ The measurement values displayed in the graph mode are the most recent values measured over the last 25 seconds.
 - ❖ If the reflection intensity bars are not indicated in green, try to increase the sensitivity for example by reducing the measuring distance (until four or more bars are lit).
 - ❖ The unit is provided with functions that give an acoustic alarm and a flashing detection lamp when it detects a column density exceeding a preset threshold. (See “5.3 Changing Settings”)

WARNING

Laser beam is on while the “LASER” on the display is lit, never direct the laser beam toward people or look into the laser beam output windows.

WARNING

When not using this product, be sure to switch it off.

Notes in methane detection

1. Upon measuring highly reflective material such as metallic material, please be careful with situations as shown in Figure A, where two guide lights (green) are visible caused by reflection, which may cause false alarms by indicating high values regardless of the presence of methane.

In such case, please point as shown in Figure B, where only a single guide light (green) can be seen.

【Figure-A : Possibility of a false alarm with high values】

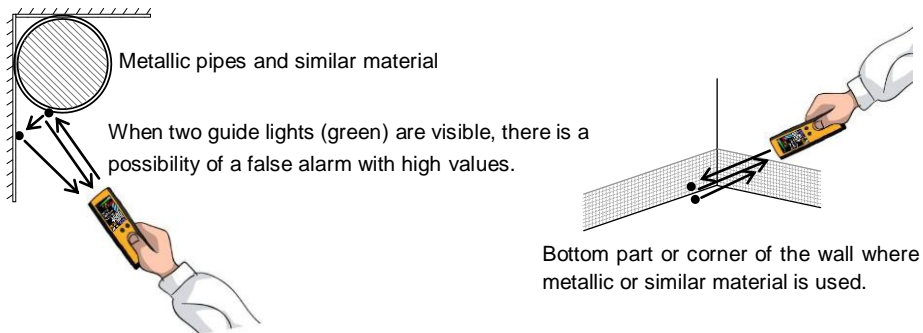

【Figure-B : To get correct value】

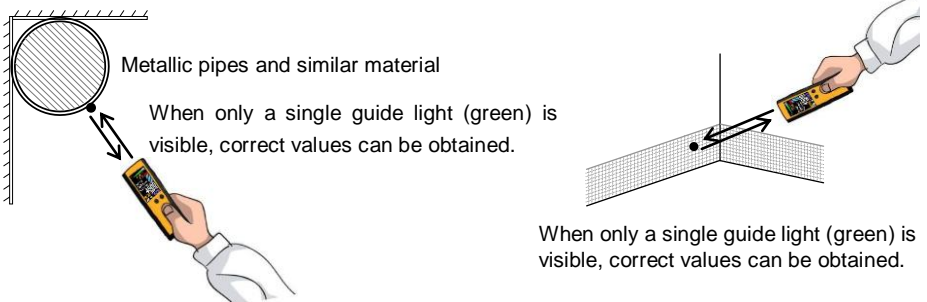

2. For a PE (polyethylene) pipe with a wall thickness of less than 10mm, please note that you may get wrong measurements if you keep pointing the laser directly at the PE pipe, because laser light penetrates through depending on its thickness.

5.3 Changing Settings

Common operations for changing settings

- The [SETTINGS] screen can be displayed in the two ways.

First way; display the [SETTINGS] screen when from the stand-by.

1. Press the Menu/Enter button when the product is powered on and on stand-by.

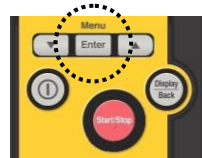

2. The [SETTINGS] screen shown on the right will be displayed.
3. Select the item from (1 to 8) with the ▲▼ buttons, and then press the Menu/Enter button.

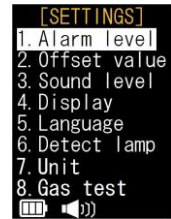

- ❖ To return to the measurement standby screen, press the Display/Back button.
- ❖ During the measurement, the [SETTINGS] screen will not be displayed.
- ❖ If you don't do the gas test described below, please select the "8. Gas test" in the [SETTINGS] screen.



Second way; display the [SETTINGS] screen when from the power is off.

1. Press the Power button for approx. 2 seconds with the Menu/Enter button kept pressed. (The product will emit a beeping sound.)
2. The [FUNCTION SELECTION] screen shown on the right will be displayed.
3. Select the [2. Settings] with the ▲ ▼ buttons.
4. Press the Menu/Enter button.
5. The [SETTINGS] screen will be displayed.
6. Select the item from (1 to 9) with the ▲ ▼ buttons, and then press the Menu/Enter button.
 - ❖ To return to the [FUNCTION SELECTION] screen, press the Display/Back button in the [SETTINGS] screen.
 - ❖ In the case, from the [SETTINGS] screen, it is not possible to go back to the measurement screen. In order to display the measurement standby screen, please switch off the power, and then switch on.
 - ❖ If you don't do the gas test described below, please select the "8. Gas test" in the [SETTINGS] screen.

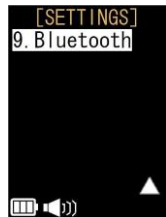
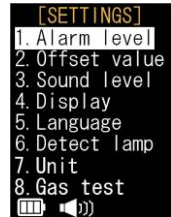
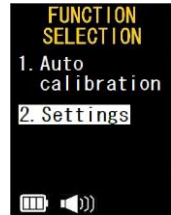

1. Alarm Level

- The methane column density level at which an alarm threshold can be set.

In the main menu select “1. Alarm level”

1. The [ALARM LEVEL] screen shown on the right will be displayed.

(The default setting value is 100 ppm·m.)

2. Select a value with the ▲▼ buttons for the 1000's digit, and then press the Menu/Enter button.

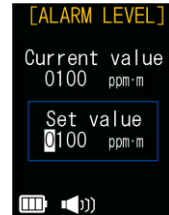

- ❖ To leave the value as indicated just press the Menu/Enter button or the Display/Back button as is.
3. Likewise, select a value for the 100's digit, 10's digit, and 1's digit.
 4. Once the setting for the 1's digit is completed, the buzzer sounds twice to indicate that the setting has been accepted.
 5. Your set value will be displayed on the numeric mode and graph mode screen.
 - ❖ The set value is not reset even when the power is switched off.
 - ❖ The alarm levels can be set up similarly for the other measuring units.
(See “7. UNIT” in this section.)

CAUTION

Set the [Alarm level] greater than the [Offset value]. If the [Alarm level] is not set greater than the [Offset value], the alarm doesn't sound and the detection lamp doesn't flash even when this product detects methane. See [2. Offset Value] about how to set the [Offset value].

2. Offset Value

- The measured value is displayed in the screen when it exceeds the offset value.

In the main menu select "2. Offset value"

1. The [OFFSET VAL.] screen shown on the right will be displayed.

(The default setting value is 0 ppm·m)

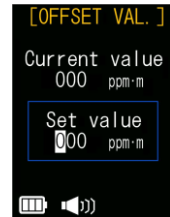

2. Select a value with the ▲ ▼ buttons for the 100's digit, and then press the Menu/Enter button.
 - ❖ To leave the value as indicated just press the Menu/Enter button or Display/Back button as is.
3. Likewise, select a value for the 10's digit, and 1's digit.
4. Once the setting for the 1's digit is completed, the buzzer sounds twice to indicate that the setting has been accepted.
5. [OFFSET] is shown on the bottom of the display.
 - ❖ The set value will not be reset when the power is switched off.
 - ❖ The offset values can be set up similarly for the other measuring units. (See "7. UNIT" in this section.)
 - ❖ If you enter the offset values greater than the maximum values, the setting screen is not closed, and the offset value is not set. The maximum values for each measuring unit are shown below.

UNIT		Maximum Value
ppm·m		500
Vol%·m		0.05
%LEL·m	100%LEL·m = 4.4 vol%·m	1.1
	100%LEL·m = 5.0 vol%·m	1.0

3. Sound Volume Level

In the main menu select “3. Sound level”

1. The [SOUND LEVEL] screen shown on the right will be displayed.
(The default setting value is 2 (middle).)
2. Adjust the sound volume level with the ▲ ▼ buttons.
3. Press the Menu/Enter button.
4. The set value will be shown on the bottom of the display.
 - ❖ The set value will not be reset even when the power is switched off.

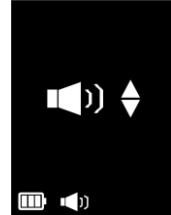

4. Screen Brightness

In the main menu select “4. Display”

1. The [DISPLAY] screen shown on the right will be displayed.
(The default setting value is 4.)
2. Adjust the brightness with the ▲ ▼ buttons.
3. Press the Menu/Enter button.
 - ❖ The set value will not be reset even when the power is switched off.



5. Display Language

In the main menu select “5. Language”

1. The [LANGUAGE] screen shown on the right will be displayed.

(The default setting value is “1. English”.)

2. Select the language with the ▲ ▼ buttons.
3. Press the Menu/Enter button.

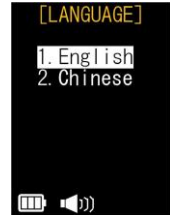

- ❖ The set value will not be reset even when the power is switched off.
- ❖ Please contact Customer Service about how to select Chinese.

6. Detection Lamp

- The detection lamp flashes when the methane column density is over the set Alarm Level.

In the main menu select “6. Detect lamp”

1. The [DETECT LAMP] screen shown on the right will be displayed.

(The default setting value is “1. Enable”)

2. Select the enable / disable with the ▲ ▼ buttons.
3. Press the Menu/Enter button.



- ❖ The set value will not be reset even when the power is switched off.

7. Unit

In the main menu select “7. Unit”

1. The [Unit] screen shown on the right will be displayed.
(The default setting value is “1. ppm·m”)
2. Select the unit with the ▲▼ buttons.
3. Press the Menu/Enter button.



When the “3. %LEL·m” is selected in the upper right screen, the [Unit] screen shown on the right will be displayed. The lower explosion limit value indicated by the column density can be selected.

1. Select the unit with the ▲▼ buttons.
2. Press the Menu/Enter button.
 - ❖ The set value will not be reset even when the power is switched off.

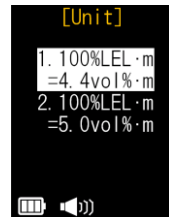

8. Gas test

- Using the gas cell, you can perform the gas test on this product. For the gas test, you should use our approved gas cell. If you have any questions on the gas cell, contact Customer Service or your local sales agent.
- About the approved gas cell, contact Customer Service or your local sales agent.
- About proceeding to the gas test, refer to the “5.6 Gas test by customer” for details.

In the main menu select “8. Gas test”

1. The [GAS TEST] screen shown on the right will be displayed.
(The default setting is “2.Disable”)
2. Select the Enable/Disable with the ▲▼ buttons.
3. Press the Menu/Enter button.
 - ❖ The set value will not be reset even when the power is switched off.
 - ❖ The gas test is performed at the time of startup.

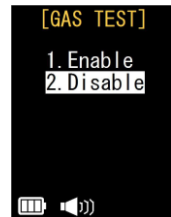

9. Bluetooth

- This function is available only Bluetooth model.
- With this product, by connecting to the Android device with the Bluetooth, you can transfer measurement data to the Android device. On the Android device, data storage and graphical display are possible with dedicated application software.
- About the Android device, the dedicated application software, and the proceeding to connection, contact Customer Service or your local sales agent.

In the main menu select “9. Bluetooth”

1. The [Bluetooth] screen shown on the right will be displayed.

(The default setting value is “2. Disable”)

2. Select the Enable/Disable with the ▲▼ buttons.
3. Press the Menu/Enter button.

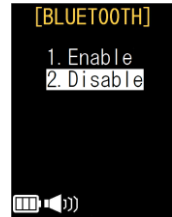

4. Bluetooth logo is shown on the bottom of the display.

❖ The set value will not be reset even when the power is switched off.

5.4 Automatic Calibration

- If “SELF TEST FAILURE” is displayed at startup, perform an automatic calibration using the procedure below.

1. After making sure that the power of the product is off, press the Power button for approx. 2 seconds with the Menu/Enter button kept pressed.
2. The [FUNCTION SELECTION] screen shown on the right will be displayed.
3. Select the [1. Auto calibration] with the ▲▼ buttons.
4. Press the Menu/Enter button.
5. Automatic calibration will start, and for 2 to 3 minutes, the [AUTO CALIBRATION] screen shown on the right will be displayed.
(The progress status can be checked with the count-down counter at the center of the screen.)
6. Upon completion of automatic calibration, the self-test is executed. The numeric mode screen shown to the right will be displayed, and the product will enter stand-by state of measurement.

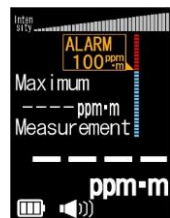
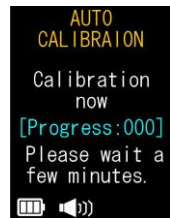
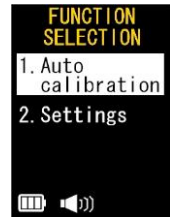
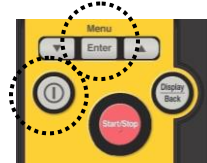

Numeric mode

- ❖ If automatic calibration does not complete successfully, it is performed again a second time.
(Time until completion will be approx. 4 to 5 minutes.)

5.5 Indicating Residual Power of Battery Pack

The battery mark shown on the display indicates the battery pack residual power.

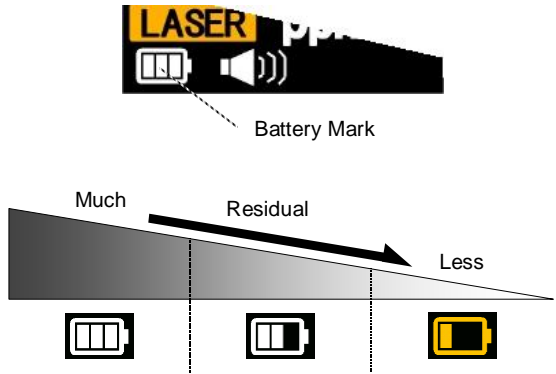

When the battery power of the battery pack is lost until this product doesn't operate, the empty screen shown on the right will be displayed, and there will be an alarm.

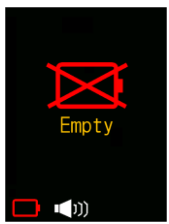

5.6 Gas test by customer

- If you set the “1. Enable” on the “8. Gas test” of the [SETTINGS] screen, when this product is started up, you can perform the gas test on this product.

1. After the startup and the self test, the [GAS TEST] proceeding screen on the right will be displayed.
2. Follow the proceedings, equip the gas cell, and press the Menu/Enter button.
3. The Gas test will start, and the performance screen shown on the right will be displayed.
4. The result will be shown.

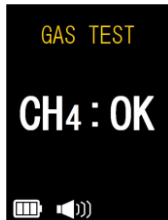

Gas test : OK

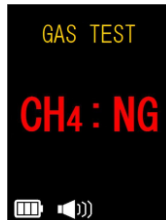

Gas test : NG

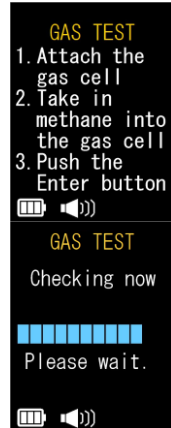

- ❖ About the proceedings of the gas test, methane concentration, and the approved gas cell, contact Customer Service or your local sales agent.
- ❖ If the [Gas test : NG] is displayed, contact Customer Service or your local sales agent.
- ❖ You can change the setting of the gas test on the [SETTINGS] screen from when this product is powered off. About how to change the setting of the gas test on the [SETTINGS] screen, please refer to the “Common operations for changing settings” in the “5.3 Changing Settings”.

5.7 Connect this product with Android device

- This function is available only Bluetooth model.
- If you set the “1. Enable” in the “9. Bluetooth” of the [SETTINGS] screen, you can transfer the measurement data to Android device with the Bluetooth.

1. After making sure that the Bluetooth logo is displayed in the bottom of the display.
2. Connect this product to the Android device.



- ❖ About the Android device, the dedicated application software, and the proceeding to connection, contact Customer Service or your local sales agent.

3. Connection between this product and the Android device is successful, [CONNECT] is displayed on the upper left of the screen.



- ❖ If [CONNECT] does not appear on the upper left of the screen, this product and the Android device are not connected.
- ❖ If this product is not connected to the Android device, the measurement data cannot be transferred to the Android device.

6. Error Messages

6.1 Explanation of Errors and Measures

When “OPERATION ERROR” is displayed

1. Switch off the power of the product.
2. (After checking that the power is switched off), switch on the power.
3. If the same error reoccurs, perform automatic calibration after making sure that the power of the product is off. (See “5.4 Automatic Calibration”)
 - ❖ If the same error message is displayed repeatedly, request repair.

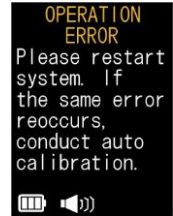

CAUSE The product is not in a measurement-enabled state.

When “SELF TEST FAILURE” is displayed

1. Switch off the power of the product.
2. (After checking that the power is switched off), switch on the power.
 - ❖ If the same error message is displayed repeatedly, perform steps 3 and 4 below.
3. Switch off the power.
4. Perform automatic calibration.

(See “5.4 Automatic Calibration”)



CAUSE The product does not meet the prescribed measurement capability.

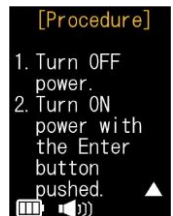

When “AUTO CALIBRATION FAILURE” is displayed

1. Switch off the power of the product.
2. (After checking that the power is switched off), perform automatic calibration.

(See “5.4 Automatic Calibration”)

- ❖ If the same error message is displayed repeatedly, request repair.

CAUSE Automatic calibration is not performed correctly.



When “PARAMETER ERROR” is displayed

1. Switch off the power of the product.
2. (After checking that the power is switched off), switch on the power.

- ❖ If the same error message is displayed repeatedly, request repair.

CAUSE Abnormal operation parameters



When “SYSTEM ERROR” is displayed

1. Switch off the power of the product.
2. (After checking that the power is switched off), switch on the power.

- ❖ If the same error message is displayed repeatedly, request repair.

CAUSE Anomaly in control block



When “Not enough reflection” is displayed

- Shorten the distance to the detection point.
- Perform measurement from a perpendicular angle rather than a slanting angle against a reflecting object at the detection point.

CAUSE Insufficient received light

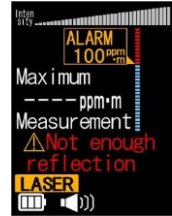

When “Too much reflection” is displayed

- Change the detection direction or the angle of the product so that external light such as sunlight does not get in the unit.
- Change the detection point so that strong light does not get in the unit.

CAUSE Strong light such as sunlight is getting inside the light receiver.

This may be caused by an object with extremely high reflection such as a mirror.

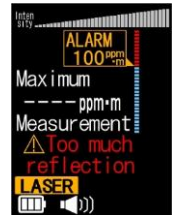

When “High density gas” is displayed

- The detectable range of this product is between 1~50,000 ppm·m.
- The full scale is 50,000 ppm·m.

CAUSE When detecting methane thicker than 50,000 ppm·m, this product cannot measure correctly.



7. IN CASE OF TROUBLE

7.1 Problems and Solutions

The product does not operate even when the Power button is pressed.

- Did you continue pressing until you hear a beep sound? (approx. 2 seconds)
(See “5.1 Starting Up and Ending”)
- Is the battery pack sufficiently charged?
Use a fully charged battery pack.
(See “4.1 Charging Battery Pack”)

No measurement beep sound is emitted

- Has the [SOUND LEVEL] setting been set to off?
(See “5.3 Changing Settings”)

No alarm of alarm

- Has the [ALARM LEVEL] setting been set to a high value?
(See “5.3 Changing Settings”)
- Has the [SOUND LEVEL] setting been set to off?
(See “5.3 Changing Settings”)

The battery pack cannot be charged

- Is the battery pack correctly attached to the battery charger?
(See “4.1 Charging Battery Pack”)
- Are the battery charger, AC adapter, AC cord, and power outlet correctly connected?
(See “4.1 Charging Battery Pack”)
- Is the red LED of the battery charger lit?
(See “4.1 Charging Battery Pack”)

8. Daily Maintenance

8.1 Maintenance Method

If the laser beam output window and the light receiver of the product are soiled, gently wipe them clean with a dry soft cloth being careful not to scratch them.



9. Main Specifications

9.1 Main Specifications of Main Unit

Items	Specifications
Target Gas	Methane (CH ₄) and methane-containing gases (natural gas and similar)
Units	ppm·m / vol%·m / %LEL·m
Detection limits	1 ~ 50,000 ppm·m (0 ~ 5.00vol%·m)
Accuracy of detection	±10 % (note)
Detection speed	0.1 seconds
Detection distance	0.5 m ~ 30 m 0.5 m ~ 100 m (using a reflect sheet)
Battery	Rechargeable nickel metal hydride
Operating time	Consecutive guide light (at 25°C, Screen Brightness: 4) Approx. 3.0 hours : with Bluetooth connected Approx. 3.5 hours : with Bluetooth disconnected Flashing guide light (at 25°C, Screen Brightness: 4) Approx. 3.5 hours : with Bluetooth connected Approx. 4.0 hours : with Bluetooth disconnected
Laser Safety	IEC60825-1 (JIS C6802) <u>Guide light</u> - Output wavelength: 520nm - Output level: 5mW (Class 3R) or less <u>Measurement light</u> - Output wavelength: 1653nm - Output level: 10mW (Class 1) or less NEVER LOOK INTO THE LASER BEAM

note) The Accuracy of detection at 100ppm·m and 1,000ppm·m on the special measurement system.

9. Main Specifications

Items	Specifications
External Communication method	Bluetooth Ver.2.1 +EDR Class2 Profile : Serial Port Profile
Applicable Standards	EMC Directive EN 61326-1 : 2013 ATEX Directive EN 60079-0 : 2012 EN 60079-11 : 2012 EN 60079-28 : 2007 R&TTE Directive EN 60950-1 : 2006 +A11 : 2009 +A1 : 2010 +A12 : 2011 EN 62479 : 2010 EN 301 489-1 V1.9.2 (2011-09) EN 301 489-17 V2.2.1 (2012-09) EN 300 328 V1.8.1 (2012-06)
Intrinsic safety	Main Unit:  I M2 II 2G Ex ib op-pr/op-is I IIA T1 Battery Pack:  I M2 II 2G Ex ib I IIA T1
Operating temperature	-17 ~ 50 °C
Operating humidity	30 ~ 90 % (No dew condensation)
Storage temperature	-20 ~ 60 °C
Storage humidity	90 % or less
Dimensions	70 (W) x 179 (D) x 42 (H) mm
Weight	600 g or less (Including Battery Pack)

9.2 Main Specifications of Battery Charger and AC Adapter

Items	Specifications
Specified battery	Dedicated Battery Pack
Charging Time	Approx. 4 hrs.
Operating temperature	5 ~ 35 °C
Operating humidity	30 ~ 90 % (No dew condensation)
Storage temperature	-10 ~ 60 °C
Storage humidity	90 % or less
AC adapter input voltage	100 ~ 240VAC
AC adapter output voltage	12VDC

 **WARNING**

Never charge the battery pack in a location with flammable gas.

 **WARNING**

The battery charger does not feature an intrinsically safe design.

10. Ordering Information

10.1 Main Unit and Standard Accessories

Model Type	Product Name	Remarks
SA3C32A	LaserMethane mini main unit : 1 unit	SA3C32A-BE : with Bluetooth support SA3C32B-NE : without Bluetooth support
SA0Z40A	Battery pack : 1 pc.	
SA0Z42A	Battery charger : 1 unit	
SA0Z47C	AC Adapter Set(EU): 1 unit	Set in there is one following SA0Z43B AC Adapter SA0Z45C Power Cable(EU)
SA0Z44B	Strap (Long type) : 1 pc.	
SA0Z41A	Protect cover : 1 pc.	
SA0Z60A	Carrying case : 1 pc.	
—	Operation manual : 1 vol.	GI-3EX15CZ009

11. Inquiries

Direct any questions about the product or reports about problems to Customer Service or to your local sales agent.

11.1 Customer Service

Equipment Sales Department

Tokyo Gas Engineering Solutions Corporation

4F, Nissey Aroma Square,

5-37-1 Kamata, Ota-ku, Tokyo, Japan 144-8721

TEL: +81-3-5480-6850

FAX: +81-3-5480-6851

URL: <http://www.tokyogas-es.co.jp/en/company/index.html>

12. Distributor and Manufacture

12.1 Distributor

Equipment Sales Department

Tokyo Gas Engineering Solutions Corporation

4F, Nissey Aroma Square

5-37-1 Kamata, Ota-ku, Tokyo, Japan 144-8721

TEL: +81-3-5480-6850

FAX: +81-3-5480-6851

URL: <http://www.tokyogas-es.co.jp/en/company/index.html>

12.2 Manufacture

Anrisu Corporation

5-1-1 Onna, Atsugi-shi, Kanagawa, 243-8555 Japan

TEL: +81-46-223-1111

URL: <http://www.anrisu.com/>

Service & Support Section

Tokyo Gas Engineering Solutions Corporation

Equipment Sales Department

4F, Nissey Aroma Square,

5-37-1 Kamata, Ota-ku, Tokyo, Japan 144-8721

TEL : +81-3-5480-6850

FAX : +81-3-5480-6851

