

Operator's Manual



McELROY

www.mcelroy.com



28 and 250 Fusion Machine

Manual: 861101 Revision: P 04/17

Original Language: English



**California
Proposition 65 Warning**

This product could expose you to chemicals known to the State of California to cause cancer, birth defects, or other reproductive harm.

This product and other products could be protected by patents or have patents pending. All the latest patent information is available at patent.mcelroy.com

Introduction

Thank you for purchasing this McElroy product

The McElroy 28 hydraulically operated fusion machine will butt fuse all pipe sizes from 2" IPS through 8" DIPS (63 mm - 225 mm).

The 250 model fuses 2" IPS (63mm) minimum to 250mm maximum pipe.

The combination unit adds saddle fusion capability of up to an 8" DIPS outlet with up to 9 5/8" diameter base on any size main. The machine also allows for butt fusion of most fittings without special holders or removal of outer jaws. Mitered inserts are also available for fabricating ells in the shop or in the field. With reasonable care and maintenance, this machine will give years of satisfactory service.

TX02502-6-5-13

Before operating this machine, please read this manual thoroughly, and keep a copy with the machine for future reference. This manual is to be considered part of your machine.



PH02481-0708-03

McElroy University

For more than 30 years, McElroy has been the only pipe fusion machine manufacturer to continuously offer advanced training. Course offerings are meant to enhance your efficiency, productivity and safety in the proper use of McElroy machines. McElroy University classes are structured so that the skills learned and the machines used in each class closely match the machines found on pipelining jobsites. We offer training at our facility or yours. Our uniquely qualified McElroy University course instructors offer years of industry experience.

Tuition for each course includes lunches, course materials and a certificate of completion. Online registration, as well as up-to-date course offerings and dates, is available at www.mcelroy.com/university

This manual is intended as a guide only and does not take the place of proper training by qualified instructors. The information in this manual is not all inclusive and can not encompass all possible situations that can be encountered during various operations.

TX04659-03-24-14



MU2-03-13-14

Warranty

LIMITED WARRANTY

McElroy Manufacturing, Inc. (McElroy) warrants all products manufactured, sold and repaired by it to be free from defects in materials and workmanship, its obligation under this warranty being limited to repairing or replacing at its factory and new products, within **5 years** after shipment, with the exception of purchased items (such as electronic devices, pumps, switches, etc.), in which case that manufacturer's warranty applies. Warranty applies when returned freight is prepaid and which, upon examination, shall disclose to have been defective. This warranty does not apply to any product or component which has been repaired or altered by anyone other than McElroy or has become damaged due to misuse, negligence or casualty, or has not been operated or maintained according to McElroy's printed instructions and warnings. This warranty is expressly in lieu of all other warranties expressed or implied. The remedies of the Buyer are the exclusive and sole remedies available and Buyer shall not be entitled to receive any incidental or consequential damages. Buyer waives the benefit of any rule that disclaimer of warranty shall be construed against McElroy and agrees that such disclaimers herein shall be construed liberally in favor of McElroy.

RETURN OF GOODS

Buyer agrees not to return goods for any reason except upon the written consent of McElroy obtained in advance of such return, which consent, if given, shall specify the terms and conditions and charges upon which any such return may be made. Materials returned to McElroy, for warranty work, repair, etc., **must have a Return Material Authorization (RMA) number**, and be so noted on the package at time of shipment. For assistance, inquiry shall be directed to:

McElroy Manufacturing, Inc.
P.O. Box 580550
833 North Fulton Street Tulsa, Oklahoma 74158-0550
PHONE: (918) 836-8611, FAX: (918) 831-9285.
EMAIL: fusion@McElroy.com

Note: Certain repairs, warranty work, and inquiries may be directed, at McElroy's discretion, to an authorized service center or distributor.

DISCLAIMER OF LIABILITY

McElroy accepts no responsibility of liability for fusion joints. Operation and maintenance of the product is the responsibility of others. We recommend qualified joining procedures be followed when using McElroy fusion equipment.

McElroy makes no other warranty of any kind whatever, express or implied; and all implied warranties of merchantability and fitness for a particular purpose which exceed the aforestated obligation are hereby disclaimed by McElroy.

PRODUCT IMPROVEMENT

McElroy reserves the right to make any changes in or improvements on its products without incurring any liability or obligation to update or change previously sold machines and/or the accessories thereto.

INFORMATION DISCLOSED

No information of knowledge heretofore or hereafter disclosed to McElroy in the performance of or in connection with the terms hereof, shall be deemed to be confidential or proprietary, unless otherwise expressly agreed to in writing by McElroy and any such information or knowledge shall be free from restrictions, other than a claim for patent infringement, is part of the consideration hereof.

PROPRIETARY RIGHTS

All proprietary rights pertaining to the equipment or the components of the equipment to be delivered by McElroy hereunder, and all patent rights therein, arising prior to, or in the course of, or as a result of the design or fabrication of the said product, are exclusively the property of McElroy.

LAW APPLICABLE

All sales shall be governed by the Uniform Commercial Code of Oklahoma, U.S.A.

Register your product online to activate your warranty: www.McElroy.com/fusion

(Copy information listed on the machine nameplate here for your records).

Model No. _____

Serial No. _____

Date Received _____

Distributor _____

Table of Contents

Equipment Safety

Safety Alerts	1-1
Read and Understand.	1-1
General Safety	1-2
Wear Safety Equipment	1-2
Heater is Not Explosion Proof	1-2
Electric Motors are Not Explosion Proof	1-2
Pipe Handling Safety	1-3
Units with Hydraulics	1-3
Electrical Safety	1-4
Crush Points	1-4
Facer Blades are Sharp	1-4
Have Tires Properly Serviced	1-5
Do Not Tow Fusion Machine at Speeds Greater than 5 MPH	1-5
Heater is Hot.	1-5
Fusion Procedures	1-5
Positioning Fusion Machine	1-6

Overview

Theory of Heat Fusion.	2-1
Introduction to the 28 and 250 Fusion Machine.	2-2
Carriage Assembly.	2-2
Chassis.	2-3
Hydraulic Fluid Reservoir.	2-3
Filter.	2-4
Motor and Pump	2-4
Relief Valve	2-4
Hydraulic Manifold Block	2-5
Hydraulic Cylinders	2-5
Facer	2-6
Heater	2-6
Heater Adapters	2-7
Pipe Lifts	2-7
Insulated Heater Stand	2-7
Electrical Box.	2-7

COPYRIGHT © 2017, 2015, 2014, 2013, 2008

McELROY MANUFACTURING, INC.

Tulsa, Oklahoma, USA

All rights reserved

All product names or trademarks are property of their respective owners. All information, illustrations and specifications in this manual are based on the latest information available at the time of publication. The right is reserved to make changes at any time without notice.

Table of Contents

Butt Fusion Procedure

Read Before Operating	3-1
Check Hydraulic Fluid Level	3-1
Connecting Machine to Power	3-1
Prepare Heater	3-2
Set up Pipe Supports	3-2
Install Clamping Inserts	3-3
Pump Motor	3-3
Loading Pipe Into Machine	3-4
Positioning Pipe In Machine	3-4
Begin Facing	3-4
After Facing	3-5
Determine Drag Pressure	3-5
Set Fusion Pressure	3-5
Check for Slippage	3-6
Check Alignment	3-6
Position Carriage for Heater Insertion	3-6
Check Heater Temperature	3-7
Select the Fusion Position	3-7
Inserting Heater	3-8
Heat Pipe	3-8
Fusing the Pipe	3-9
Opening Movable Jaws	3-9
Opening Fixed Jaws	3-9
Raise Pipe	3-10
Position Pipe for Next Joint	3-10
Install Next Piece of Pipe	3-10

Special Operations - In Ditch

Remove Facer from Machine	4-1
Remove Carriage Assembly from the Chassis	4-1
Outrigger	4-2
Remove 3-Jaw Assembly from the Carriage	4-3
Manual Facer Operation	4-4
Removing Top Jaws	4-4
Lower 3-Jaw or 4-Jaw Carriage into the Ditch	4-5
Lower Carriage into Ditch	4-5
Clamp Carriage Assembly to Pipe	4-6
Make Fusion Joint	4-7
Remove Carriage Assembly from Ditch	4-7
Reassemble Fusion Machine	4-7

Special Operations - Saddle Fusion Procedures

Saddle Fusion Procedure	5-1
Install Heater Adapters	5-1
Assure Saddle Will Fit	5-1
Install Clamping Inserts	5-2
Attach Carriage Assembly to Main	5-2
Set Hydraulic Pressure	5-2
Clean Surfaces	5-2
Clamp Fitting	5-3

Table of Contents

Special Operations - Saddle Fusion Procedures (Continued)

Test for Slippage	5-3
Prepare Heater	5-3
Heat Pipe and Fitting	5-4
Remove Heater	5-4
Fuse Fitting to Pipe	5-4
Allow Joint to Cool.	5-4

Special Operations - Lifting Fusion Machine

Lifting Safety	6-1
Required Equipment	6-2
Install Pipe Pieces	6-2
Ready the Unit for Lifting.	6-2
Attach Slings	6-3
Lift Equipment	6-3

Maintenance

Preventative Maintenance	7-1
Washing the Machine	7-1
Check Hydraulic Fluid.	7-1
Change Hydraulic Fluid and Filter	7-1
Check Gauge Calibration	7-2
Clean Jaws and Inserts	7-2
Clean Thrust Bearings.	7-2
Clean Eyebolt Threads	7-2
Clean the Clamping Chains	7-3
Fasteners Must Be Tight.	7-3
Facer	7-3
Facer Blades	7-3
Clean Heater Surfaces	7-4
Bleeding Air From Hydraulic System	7-4
Installing Butt Fusion Heater Plates	7-5
Adjusting Heater Temperature	7-5
Heater Indicator Light	7-5

Machine Maintenance Checklist

Fusion Machine Checklist	8-1
------------------------------------	-----

Determining Fusion Pressure

Determining Fusion Pressure	9-1
---------------------------------------	-----

Hydraulic Fluid

Hydraulic Fluid Characteristics	10-1
---	------

Specifications

Fusion Machine Specifications	11-1
Generator Sizing Form	11-3

Fusion Equipment Safety

Safety Alerts



This hazard alert sign appears in this manual. When you see this sign, carefully read what it says. YOUR SAFETY IS AT STAKE.

You will see the hazard alert sign with these words: DANGER, WARNING, and CAUTION.



Indicates an imminently hazardous situation which, if not avoided, will result in death or serious injury.



Indicates a potentially hazardous situation which, if not avoided, could result in death or serious injury.



Indicates a hazardous situation which, if not avoided, may result in minor or moderate injury.



In this manual you should look for two other words: **NOTICE** and **IMPORTANT**.

NOTICE: can keep you from doing something that might damage the machine or someone's property. It may also be used to alert against unsafe practices.

IMPORTANT: can help you do a better job or make your job easier in some way.

TX00030-12-1-92

WR00051-1-30-92

Read and Understand

Do not operate this equipment until you have carefully read, and understand all the sections of this manual, and all other equipment manuals that will be used with it.

Your safety and the safety of others depends upon care and judgment in the operation of this equipment.

Follow all applicable federal, state, local, and industry specific regulations.

McElroy Manufacturing, Inc. cannot anticipate every possible circumstance that might involve a potential hazard. The warnings in this manual and on the machine are therefore not all inclusive. You must satisfy yourself that a procedure, tool, work method, or operating technique is safe for you and others. You should also ensure that the machine will not be damaged or made unsafe by the method of operation or maintenance you choose.



TX02946-4-15-09

WR00052-12-1-92

Fusion Equipment Safety

General Safety

Safety is important. Report anything unusual that you notice during set up or operation.

LISTEN for thumps, bumps, rattles, squeals, air leaks, or unusual sounds.

SMELL odors like burning insulation, hot metal, burning rubber, hot oil, or natural gas.

FEEL any changes in the way the equipment operates.

SEE problems with wiring and cables, hydraulic connections, or other equipment.

REPORT anything you see, feel, smell, or hear that is different from what you expect, or that you think may be unsafe.

TX00114-4-22-93



SAFE1ST-1222-92

Wear Safety Equipment

Wear a hard hat, safety shoes, safety glasses, and other applicable personal protective equipment.

Remove jewelry and rings, and do not wear loose-fitting clothing or long hair that could catch on controls or moving machinery.

TX00032-4-7-93

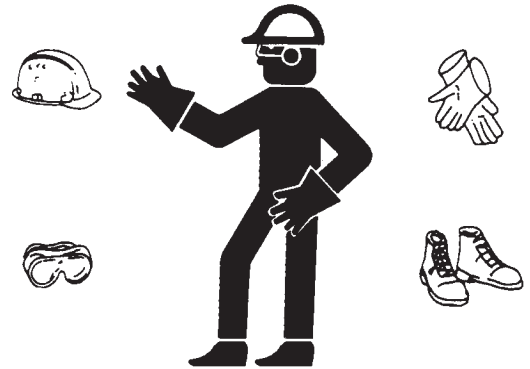

WR00053-1222-92

Heater is Not Explosion Proof

⚠ DANGER This heater is not explosion proof. Operation of heater in an explosive atmosphere without necessary safety precautions will result in serious injury or death.

When operating in an explosive atmosphere, the heater should be brought up to temperature in a safe environment, then unplugged before entering the explosive atmosphere for fusion.

TX04467-03-24-14



WR00034-11-30-92

Electric Motors are Not Explosion Proof

⚠ DANGER Electric motors are not explosion proof. Operation of these components in an explosive atmosphere without necessary safety precautions will result in serious injury or death.

When operating in an explosive atmosphere, keep pump motor and chassis in a safe area by using hydraulic extension hoses.

TX00424-04-28-14



WR00060-4-12-93

Fusion Equipment Safety

Pipe Handling Safety

⚠ WARNING Do not position yourself under supported or raised pipe. Pipe is heavy and could result in serious injury or death.

⚠ WARNING Pipe that is bent can store a great amount of energy. Do not bend and force the pipe into the machine. A bent pipe with stored energy could cause serious injury or death when that energy is released.

It is recommended that the pipe is always be held securely by either being clamped securely in the fusion machine jaws or attached to the lifting device.

Ensure all portions of the pipe and fittings are clear before lifting the pipe from the machine. If the pipe becomes bound in the machine, do not continue to lift the pipe. Lower the pipe into the machine and ensure the pipe is clear before lifting again.

Keep persons that are not involved in handling pipe away from handling operations. Persons that are involved with handling operations keep away from the pipe when the pipe and handling equipment are in motion. When the pipe and handling equipment are in motion, all persons involved in handling pipe should be able to see all other persons at all times. If any handling person is not in sight, immediately stop moving equipment and pipe and locate that person. Do not continue until all persons are accounted for and in sight.

NOTICE: Do not leave machine unattended while the Power Pack is running. When not operating the machine, turn off the Power Pack. This will prevent accidental or unintentional movement of the machine.

Never push, roll, dump or drop pipe lengths, bundles or coils off the truck, off handling equipment or into a trench. Always use appropriate equipment to lift, move and lower the pipe.

TX04586-0724-14

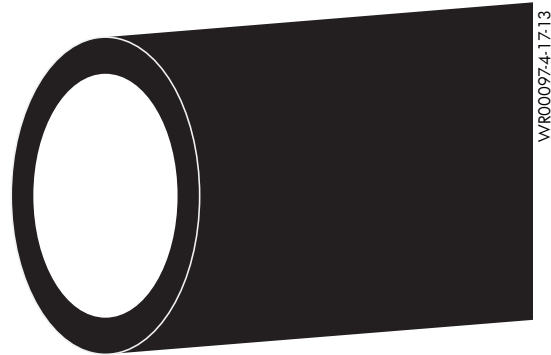

Units With Hydraulics

For hydraulically operated equipment, it is important to remember that a sudden hydraulic oil leak can cause serious injury, or even be fatal if the pressure is high enough.

⚠ WARNING Escaping fluid under pressure can penetrate the skin causing serious injury. Keep hands and body away from pinholes which eject fluid under pressure. Use a piece of cardboard or paper to search for leaks. If any fluid is injected into the skin, it must be immediately removed by a doctor familiar with this type of injury.

NOTICE: wear safety glasses, and keep face clear of area when bleeding air from hydraulic system to avoid spraying oil into eyes.

TX030772-16-10



Fusion Equipment Safety

Electrical Safety

⚠️ WARNING Always ensure power cords are properly grounded. It is important to remember that you are working in a wet environment with electrical devices. Proper ground connections help to minimize the chances of an electric shock.

Frequently inspect electrical cords and unit for damage. Have damaged components replaced and service performed by a qualified electrician.

Do not carry electrical devices by the cord.

NOTICE: Always connect units to the proper power source as listed on the unit, or in the owner's manual. On units with two power cords, plug each cord into separate power circuits. Do not plug into both outlets of one duplex receptacle.

⚠️ WARNING Disconnect the machine from the power source before attempting to service the control panel. Failure to disconnect the power could result in electric shock. Refer service to a qualified technician.

TX00105-5-6-13



WR00055-4-7-93



WR00025-11-30-92

Crush Points

⚠️ WARNING Hydraulically operated jaws are operated under pressure. Anything caught in the jaws will be crushed. Keep all body parts out of the jaw area. Always check pipe alignment with a pencil or similar object.

TX03091-4-7-10



WR00012-1-24-92

Facer Blades Are Sharp

⚠️ WARNING Facer blades are sharp and can cut. Never attempt to remove shavings while the facer is running, or is in the facing position between the jaws. Use care when operating the facer, and when handling the unit.

NOTICE: Disconnect power from the facer, and remove the facer blades before attempting any maintenance or adjustment.

NOTICE: Never extend the blade beyond the inner or outer circumference of the facer.

TX02378-1-24-05

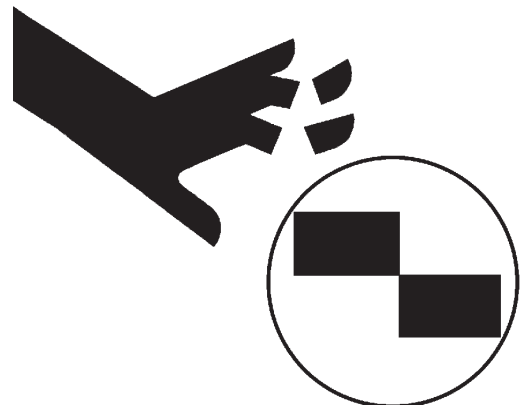

WR00073-4-6-93

Fusion Equipment Safety

Have Tires Properly Serviced

⚠️ WARNING

Failure to follow proper procedures when mounting a tire on a wheel or rim can produce an explosion which may result in serious injury or death. Have tires mounted by someone that is experienced, and has the proper equipment to perform the job safely.

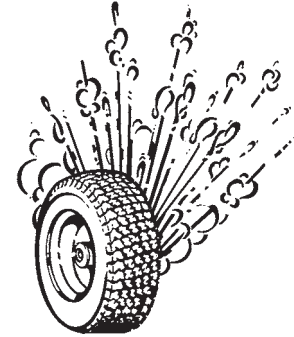

TX00118-4-22-93

WR00083-4-22-93

Do Not Tow Fusion Machine at Speeds Greater than 5 MPH

⚠️ WARNING

The chassis is not designed for over-road towing. Towing at speeds greater than five miles per hour can result in machine damage as well as injury. Always transport the machine by flatbed truck or similar means, and make sure that unit is properly secured.

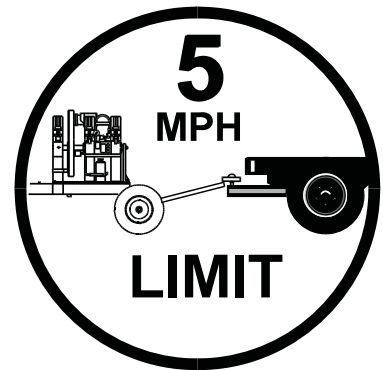

TX00101-4-12-93

CD00189-1-24-96

Heater Is Hot

⚠️ CAUTION

The heater is hot and will burn clothing and skin. Keep the heater in its insulated heater shroud when not in use, and use care when heating the pipe.

NOTICE: Use only a clean non-synthetic cloth to clean the heater plates.



TX04244-10-12-10

WR00030-2-10-93

Fusion Procedures

Obtain a copy of the pipe manufacturer's procedures or appropriate joining standard for the pipe being fused. Follow the procedure carefully, and adhere to all specified parameters.

NOTICE: Failure to follow pipe manufacturer's procedure could result in a bad joint. Always follow pipe manufacturer's procedures.

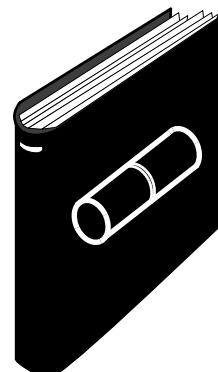

TX04469-10-24-12

WR00079-1-24-96

Fusion Equipment Safety

Positioning Fusion Machine

Place fusion machine on as level ground as possible, and set the brake on the rear wheel. If it is necessary to operate machine on unlevel grade, chock the wheels and block the unit to make it as stable as possible.

TX001129-15-94

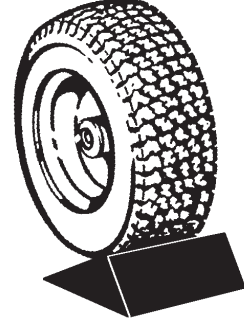

WR00076-4-793

Overview

Theory of Heat Fusion

The principle of heat fusion is to heat two surfaces to a designated temperature, and then fuse them together by application of force. This pressure causes flow of the melted materials, which causes mixing and thus fusion. When the polyethylene material is heated, the molecular structure is transformed from a crystalline state into an amorphous condition. When fusion pressure is applied, the molecules from each polyethylene part mix. As the joint cools, the molecules return to their crystalline form, the original interfaces are gone, and the fitting and pipe have become one homogeneous unit. A strong, fully leak tight connection is the result.

The principal operations include:

- Clamping** The pipe pieces held axially to allow all subsequent operations to take place.
- Facing** The pipe ends must be faced to establish clean, parallel mating surfaces perpendicular to the centerline of the pipes.
- Aligning** The pipe ends must be aligned with each other to minimize mismatch or high-low of the pipe walls.
- Heating** A melt pattern that penetrates into the pipe must be formed around both pipe ends.
- Joining** The melt patterns must be joined with a specified force. The force must be constant around the interface area.
- Holding** The molten joint must be held immobile with a specified force until adequately cooled.
- Inspecting** Visually examine the entire circumference of the joint for compliance with standards established by your company, customer, industry, federal, state, or local regulations.

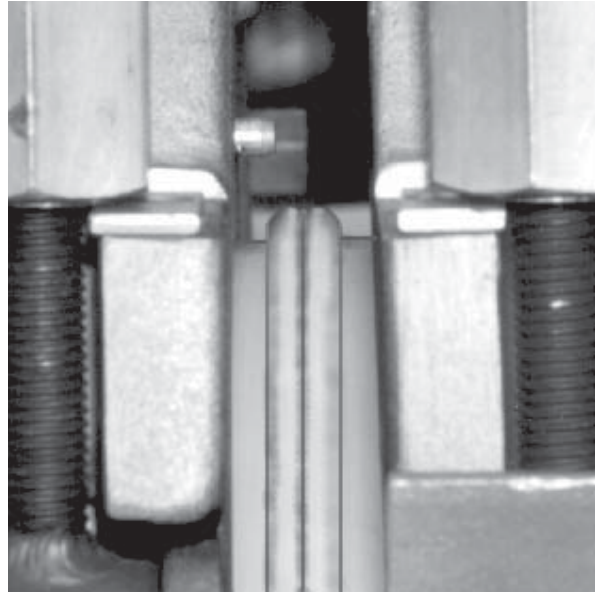

PH00363B-1-4-96

Overview

Introduction to the 28 and 250 Fusion Machine

The McElroy 28 hydraulically operated fusion machine will butt fuse all pipe sizes from 2" IPS through 8" DIPS (63 mm - 225 mm). The combination unit adds saddle fusion capability of up to an 8" DIPS outlet with up to 9 5/8" diameter base on any size main. The machine also allows for butt fusion of most fittings without special holders or removal of outer jaws.

The 250 model fuses 2" IPS (63mm) minimum to 250mm maximum pipe.



PH02481-07-08-03

TX01309-06-05-13

Carriage Assembly

The carriage assembly consists of two fixed jaws and two hydraulically operated movable jaws bolted to the skid. For remote operation the carriage can be set in ditch and connected to the machine with optional hydraulic extension hoses. The carriage assembly (A) can be disconnected from the chassis (B) and removed for remote operation. The optional extension hose kit is required for this operation.

For tight installations the outer fixed jaw and skid can be removed from the carriage for an even more compact fusion unit.



PH02499-09-18-03



PH02505-09-18-03



PH02500-09-18-03

TX01891-11-15-00

Overview

Chassis

The carriage assembly is mounted on a four wheel chassis for mobility and movement along the pipe line.

There is a pinned wheel lock on the left rear wheel to prevent rolling.

⚠ WARNING

The chassis is not designed for over-road towing. Towing at speeds greater than five miles per hour can result in machine damage as well as injury. Always transport the machine by flatbed truck or similar means, and make sure that unit is properly secured.

The tongue on the tow bar has a ring to slip over a ball hitch so that the machine may be conveniently maneuvered at the job site.

The tow bar acts as front pipe lift when raised.

The chassis is not designed for over-road towing.



PH02969-3-29-05



PH02484-07-08-03

TX02129-07-08-03

Hydraulic Fluid Reservoir

The reservoir is incorporated in the chassis. The fluid level should remain visible in the sight gauge in the side of the filler spout.

Never allow dirt or other foreign matter to enter the open tank.

Refer to the "Hydraulic Fluids" section of this manual for hydraulic fluid recommendations.



PH02483-07-08-03

TX00353-04-28-14

Overview

Filter

This machine is equipped with a 10 Micron filter on the return line.

TX02132-07-08-03



PH02485-07-08-03

Motor and Pump

The pump is powered by a TEFC capacitor start motor. The pump is a Hi/Low Gear Pump and is set to give maximum flow up to 300 psi. At this pressure, an internal sequence valve shifts to a lower flow and reduces the load on the motor.

⚠ DANGER Electric motors are not explosion proof. Operation of these components in an explosive atmosphere without necessary safety precautions will result in serious injury or death.

⚠ CAUTION Do not adjust the sequence valve (A) higher on the pump. This will overload the motor.

TX00355-1-14-14



PH02486-07-08-03

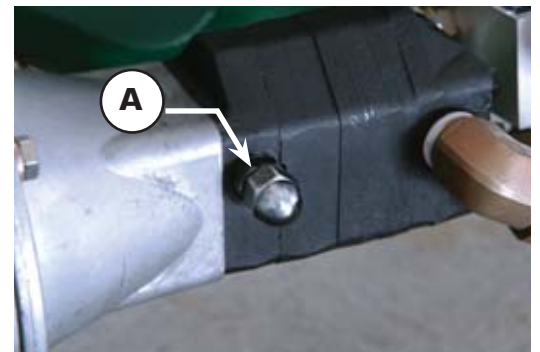

PH02487-07-08-03

Relief Valve

The overall system pressure is set with the relief valve (B) mounted off the pump. This pressure is set at 900 psi and is sufficient for most pipe.

When working with heavy wall pipe, it may be necessary to increase the pressure to 1200 psi for the facing operation. Reduce the pressure to 900 psi when facing is completed.

NOTICE: Prolonged operation at increased pressure can over-heat the oil.

TX02131-07-08-03

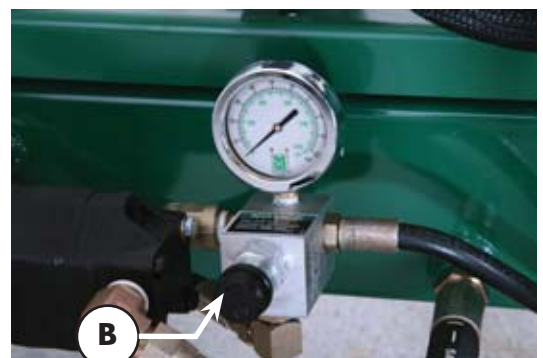

PH02488-07-08-03

Overview

Hydraulic Manifold Block

Mounted on this block are a carriage directional control valve, a pressure reducing selector valve, three pressure reducing valves, and a 1500 psi gauge.

- A) The carriage control valve, mounted on the top of the manifold, determines whether the carriage is moving left, right, or is in neutral.
- B) A 1500 psi gauge is mounted on top of the manifold.
- C) The selector valve, mounted on the front of the manifold, selects a reduced pressure from one of the pressure reducing valves.

Each pressure reducing valve is labeled with a different function:

- D) The top valve adjusts facing pressure to a maximum of 400 psi.
- E) The middle valve adjusts heating pressure to a maximum of 400 psi.
- F) The bottom valve adjusts fusion pressure to a maximum of 1500 psi.



PH02489-07-08-03

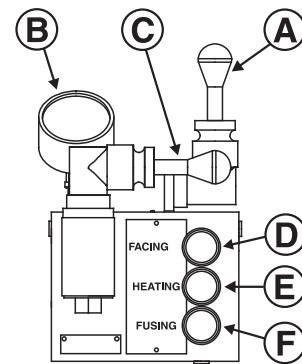

CD00138A-9-1294

TX02133-07-08-03

Hydraulic Cylinders

The two carriage cylinders have air bleed screws and must be bled if the system ever runs low on oil or leaks air on inlet side of pump. Air in the system is indicated when carriage movement becomes jerky and erratic.

Consult the "Maintenance" section of this manual for procedure to follow when bleeding air from system.

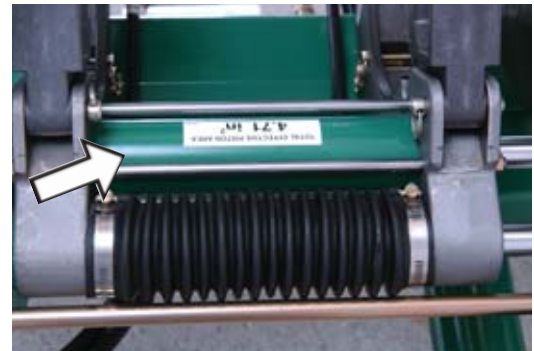

PH02490-07-08-03

TX01137-10-23-96

Overview

Facer

The facer is of the McElroy rotating planer-block design. The blade holders each contain two cutter blades. The block rotates on ball bearings and is chain driven (enclosed in lubricant) by a hydraulic motor. The facer weighs approximately 40 pounds and is pivoted on a shaft attached to the two movable jaws. The facer has a release mechanism on the pivot side for quick and easy removal from the machine.

NOTICE: Never extend the blade beyond the inner or outer circumference of the facer.

TX02134-07-08-03



PH02491-07-08-03



PH02493-07-08-03

Heater

⚠ DANGER Heater is not explosion proof. Operation of heater in an explosive atmosphere without necessary safety precautions will result in serious injury or death.

If operating in an explosive atmosphere, heater should be brought up to temperature in a safe environment, then **unplugged before entering** the explosive atmosphere for fusion.

The heater temperature is controlled by a microprocessor. The heater has a green indicator light which will flash on and off. This indicates that the controller is operating normally. It has a red indicator light. When the heater is plugged in and preheating the red light glows steadily until the set temperature is reached. The red light then goes off and on as the heater maintains temperature.

The heater body is not coated. Coated butt fusion heater plates are available for all butt fusion applications.

NOTICE: The heater should never be used without butt fusion heater plates installed.

To prevent a build-up of plastic pipe residue from accumulating on the heater plates (loss of surface temperature and pipe sticking may result), the heater plates should be cleaned with a non-synthetic cloth before every fusion joint.

TX02981-01-03-14



PH03874-6-5-13



PH04929-6-5-13

Overview

Heater Adapters

Heaters and heater adapters are available for saddle fusion of tapping tees, stopple fittings, and branch saddles.

NOTICE: The heater should never be used without butt fusion heater adapters installed.

TX00362-9-22-94

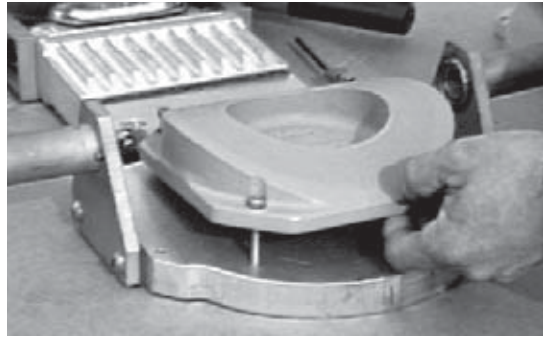

PH00416-11-1-94

Pipe Lifts

Pipe lifts are provided to assist in pipe handling. The pipe lifts can be secured using detent pins during machine transport or movement of pipe.

TX00469-9-15-94



PH02492-07-08-03

Insulated Heater Stand

The heater should always be stored in the insulated heater stand or blanket for protection of the operator and to minimize heat loss and risk of mechanical damage.

TX00363-9-15-94



PH03874-6-5-13

Electrical Box

The main power switch is located on the outside of the electrical box. Next to the power switch is a digital volt meter. This meter shows the incoming voltage to the unit. Located on the side of the electrical box is an hour meter that indicates how many hours the unit has been in operation. Also included is a motor circuit breaker.

TX00470-9-15-94

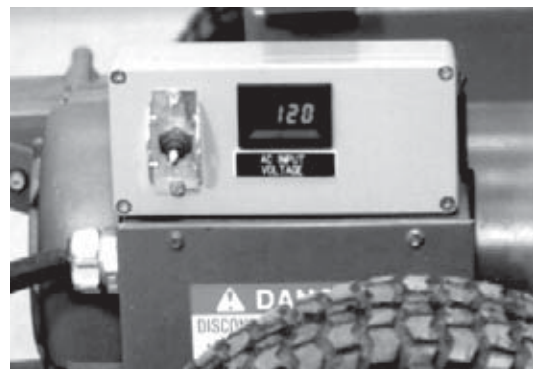

PH00348-9-9-94

Butt Fusion Procedure

Read Before Operating

Before operating this machine, please read this manual thoroughly, and keep a copy with the machine for future reference.

Return manual to the protective storage box when not in use. This manual is to be considered part of your machine.

TX00401-9-15-94



STOP-122292

Check Hydraulic Fluid Level

Check fluid level in sight gauge on filler spout and add fluid if necessary.

Refer to the "Hydraulic Fluids" section of this manual for hydraulic fluid recommendations.

TX00364-05-09-14



PH02483-07-08-03

Connecting machine to Power



All electrical equipment and power sources must be located outside an explosive atmosphere. Failure to do so can result in serious injury or death.

Plug machine's electrical cord into a proper power source.

TX00668-05-09-14



PH00348-9-12-94

Butt Fusion Procedure

Prepare Heater



Heater is not explosion proof. Operation of heater in an explosive atmosphere without necessary safety precautions will result in serious injury or death.

If operating in an explosive atmosphere, heater should be brought up to temperature in a safe environment, then unplugged before entering the explosive atmosphere for fusion.

Install butt fusion heater plates.

NOTICE: The heater should never be used without butt fusion heater plates installed. Refer to the "Maintenance" section of this manual for installation procedure.

Place heater in insulated heater stand.

Plug heater into a proper power source.

Allow heater to warm-up to operating temperature.

Refer to the "Maintenance" section of this manual for instructions on how to adjust heater temperature.



PH03874-6-5-13



PH00420-11-1-94

TX02310-03-24-14

Set up Pipe Supports

Set up pipe stands and adjust height so the pipe is in line with the jaws.



PH02556-09-18-03

TX00367-9-15-94

Butt Fusion Procedure

Install Clamping Inserts

Select and install appropriate clamping inserts for the pipe that is being fused.

Clamping inserts are required for all sizes except 8" DIPS.

TX01310-4-1-97

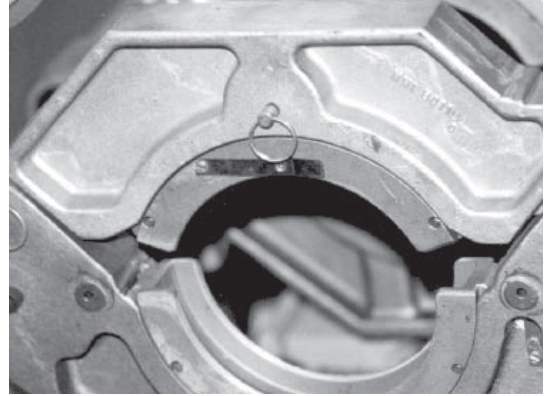

PH003049-24-93

Pump Motor



Electric motors are not explosion proof. Operation of these components in an explosive atmosphere without necessary safety precautions will result in serious injury or death.

For operation in an explosive atmosphere consult the instructions in the "Special Operation" section of this manual.

Locate pump motor in a safe environment. Plug the electrical cord into a proper power source.

Turn on hydraulic pump motor and note pressure at the relief valve.

Set the system pressure to 900 psi for most pipe sizes and SDR's. When facing heavy wall pipe, it may necessary to increase the pressure to 1200 psi. Reduce the pressure to 900 psi when facing is completed. Prolonged operation at increased pressure can over-heat the oil

IMPORTANT: Unplug heater when starting pump motor. This will reduce the load on the power supply.

TX02135-05-09-14



PH02486-07-08-03



PH02488-07-08-03

Butt Fusion Procedure

Loading Pipe Into Machine

Clean the inside and outside of pipe ends that are to be fused.
Open the upper jaws and insert pipe in each pair of jaws with applicable inserts installed. Let the ends of the pipe protrude about 1" past the face of the jaws.

TX00371-9-15-94

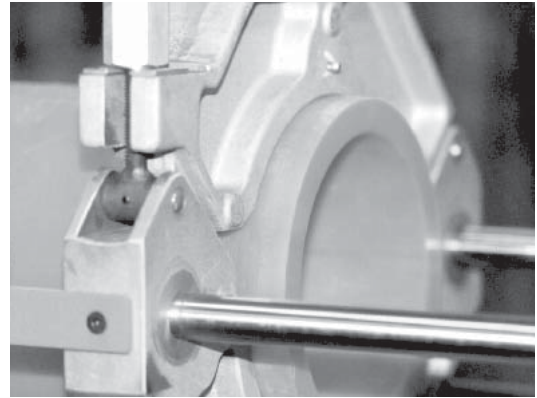

PH00306-9-24-93

Positioning Pipe In Machine

Swing the facer into place. With the carriage control valve lever, move the carriage toward the fixed jaws, while watching the gap at each end of the facer rest buttons. When the pipe is in contact with the facer, this gap indicates the amount of material that will be trimmed from the pipe end. Assure sufficient material will be removed for a complete face off. Tighten the clamp knobs on the outside jaws. Hand tighten the inside clamp knobs.

TX00372-9-15-94



PH00355-9-9-94

Begin Facing

Turn facer on by opening valve on top of the facer.
Move the selector valve on the hydraulic manifold block to the top (facing pressure) position.
The facing pressure should be set as low as possible while still facing pipe. Excessive facing pressure can damage the facer. It may be necessary to adjust the carriage pressure.



WARNING Facer blades are sharp and can cut. Never attempt to remove shavings while the facer is running, or is in the facing position between the jaws. Use care when operating the facer, and when handling the unit.

Activate the carriage control valve and move the carriage to the left to begin facing. Continue to face the pipe until the rest buttons on the jaws bottom out on the facer rest buttons.

TX04261-3-30-11



PH02494-07-08-03

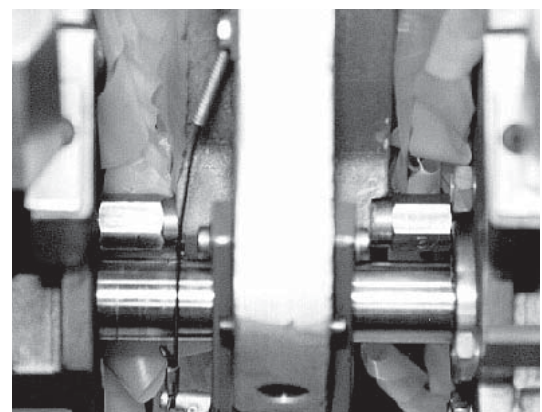

PH00359-9-12-94

Butt Fusion Procedure

After Facing

Turn facer motor off. Move carriage all the way to the right. Center the facer in between the pipe ends to avoid dragging facer stops on the pipe ends. Swing facer to the out position. Clean shavings out of pipe ends and from between the jaws. Do not touch faced pipe ends.



PH02491-07-08-03

TX04262-3-30-11

Determine Drag Pressure

Drag pressure should be determined using the following procedure:

Move the carriage so that the faced pipe ends are approximately 2" apart.

Shift the carriage control valve to the middle (neutral) position.

Select the heating mode, and adjust the middle pressure reducing valve to its lowest pressure by turning the valve counterclockwise.

Shift the carriage control valve to the left.

Gradually increase the pressure by turning the valve clockwise. Increase the pressure until the carriage moves.

Quickly reduce the heating pressure valve counterclockwise until the carriage is just barely moving.

Record this actual drag pressure.

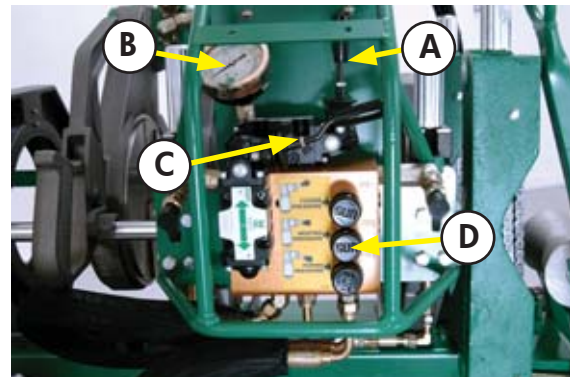

PH02489-07-08-03

- A - Carriage Control Valve
- B - Pressure Gauge
- C - Pressure Selector Valve
- D - Pressure Reducing Valves (3)

TX03023-8-19-09

Set Fusion Pressure

With the selector valve in the down position, the fusion pressure can be set.

The theoretical fusion pressure can be calculated using the enclosed fusion pressure calculator. Always add drag pressure to the theoretical fusion pressure.

Gauge (Fusion) Pressure = Theoretical Fusion Pressure + Drag Pressure



PH04004-8-25-09

TX03024-10-19-10

Butt Fusion Procedure

Check for Slippage

Bring the two sections of pipe together under fusion pressure to make sure they don't slip in the jaws.

If slippage occurs, return to **Loading Pipe into Machine**.

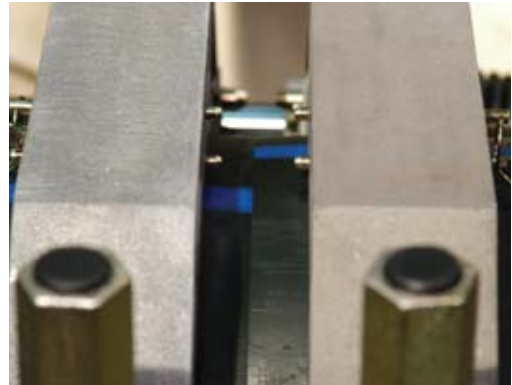

PH04464-1-3-1-11

TX00971-12-7-10

Check Alignment

Move carriage to the left at facing pressure, until pipe ends contact. Look across the top surface of pipe ends to check alignment. If there is a noticeable step across the joint, adjustments must be made.

WARNING Hydraulically operated equipment is operated under pressure. Anything caught in the machine will be crushed. Keep fingers, feet, arms, legs, and head out of the machine while operated.

If pipe is not lined up, tighten the high side jaw to bring into alignment.

IMPORTANT: Always tighten the side that is higher, never loosen the low side.

When the pipe is properly aligned, ensure all clamp knobs are tight.

NOTICE: When clamping, do not over-tighten the clamp knobs because machine damage can result. Check to see if there is space between the upper and lower jaws. If the two jaws are touching, do not continue to tighten.

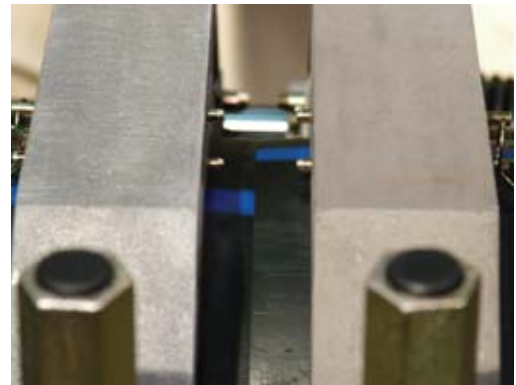

PH04464-1-3-1-11

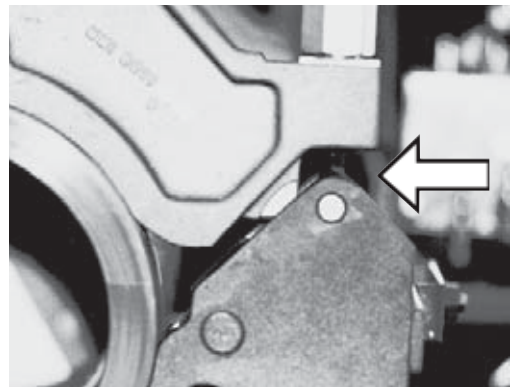

PH00323-9-25-93

TX04263-3-30-11

Position Carriage for Heater Insertion

Move carriage to the right to open a gap large enough to insert the heater.

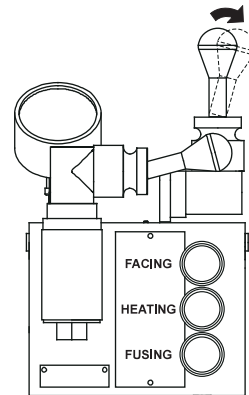

TX00374-9-15-94

CD00138D-9-12-94

Butt Fusion Procedure

Check Heater Temperature

NOTICE: Incorrect heating temperature can result in questionable fusion joints. Check heater plates periodically with a pyrometer and make necessary adjustments.

Refer to the "Maintenance" section of this manual for instructions how to adjust heater temperature.

Check heater surface temperature.

Refer to the pipe manufacturer's recommendations for proper heater temperature.



WR00077-4-16-93

IMPORTANT: The dial thermometer on the heater indicates internal temperature which varies from the actual surface temperature.

The dial thermometer can be used as reference once the surface temperature has been verified.



PH00420-11-1-94

TX02001-11-1-02

Select the Fusion Position

Move selector valve handle down to the fusing position.

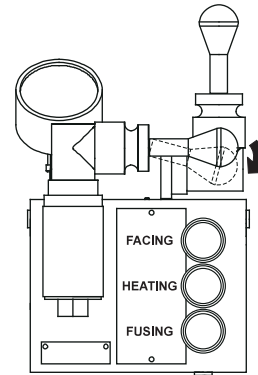

CD00138E-9-12-94

TX00376-9-15-94

Butt Fusion Procedure

Inserting Heater



Heater is not explosion proof. Operation of heater in an explosive atmosphere without necessary safety precautions will result in serious injury or death.

If operating in an explosive atmosphere, heater should be brought up to temperature in a safe environment, then unplugged before entering the hazardous atmosphere for fusion.

Use a clean non-synthetic cloth to clean the butt fusion heater adapter surfaces.

Verify heater temperature by noting the reading on the dial thermometer.

Insert heater between the pipe ends.



PH04929-6-5-13



PH02495-07-08-03

TX00377-04-16-14

Heat Pipe

Shift the selector valve (A) to the center position, and set the heating pressure (if required). If heating pressure is not required, set the pressure reducing valve (B) at its lowest setting, or the drag pressure, whichever is higher.

Shift the selector valve (A) to the fusion position and move the carriage control valve (C) to the left to bring pipe ends in contact with the heater. Move selector valve (A) to middle (heating mode) position. If heater pressure is not required by pipe manufacturer or joining standard, or opposing forces are not great enough to move the carriage away from the heater, shift the carriage control valve to neutral.

IMPORTANT: Always shift into the heating mode **before** returning carriage valve to neutral.

Follow the pipe manufacturer's suggested heating and soaking procedure or joining standard.

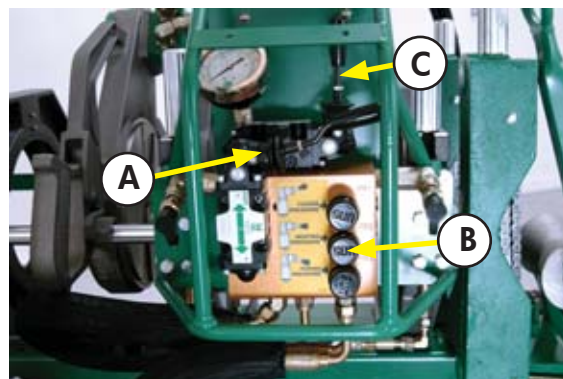

PH02489-07-08-03



PH04465-1-31-11

TX04264-3-30-11

Butt Fusion Procedure

Fusing the Pipe

NOTICE: Failure to follow the pipe manufacturer's heating time, pressure and cooling time may result in a bad joint.

After following the heating procedure, verify carriage control valve is in neutral and move selector valve down, to fusion position.

Move the carriage to the right just enough to remove the heater.

Quickly remove the heater.

Quickly inspect pipe ends for appropriate melt.

When heater is clear of the jaws, quickly move the carriage to the left and bring the pipe ends together using the pipe manufacturer's recommended pressure.

Allow joint to cool under pressure according to pipe manufacturer's recommendations or appropriate joining standard.

Visually examine the entire circumference of the joint for compliance with standards established by your company, customer, industry, federal, state, or local regulations.

TX04265-1-20-12

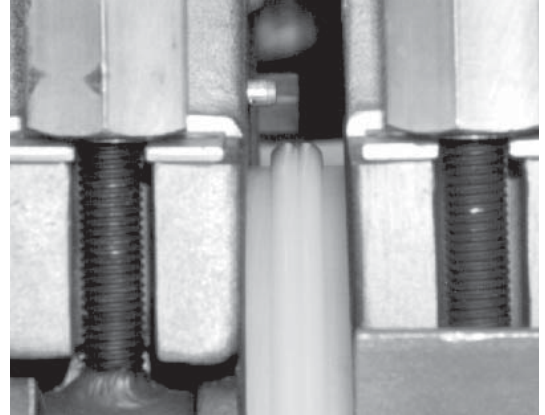

PH00363-9-12-94

Opening Movable Jaws

After the joint has cooled for the pipe manufacturer's recommended time or appropriate joining standard, shift the carriage control valve to the neutral position.

Loosen all clamp knobs, and move carriage to the right far enough to open the jaw nearest the facer.

Open the movable jaws.

TX00380-9-15-94



PH02318-4-24-02

Opening Fixed Jaws

Open the fixed jaws.

TX00381-9-16-94



PH02496-07-08-03

Butt Fusion Procedure

Raise Pipe

Raise the joined pipe using both of the pipe lifts.



PH02492-07-08-03

TX00382-9-16-94

Position Pipe for Next Joint

Move the fusion machine to end of pipe, or pull the pipe through the jaws until the end of the pipe is protruding 1" past the jaw face of the fixed jaw.

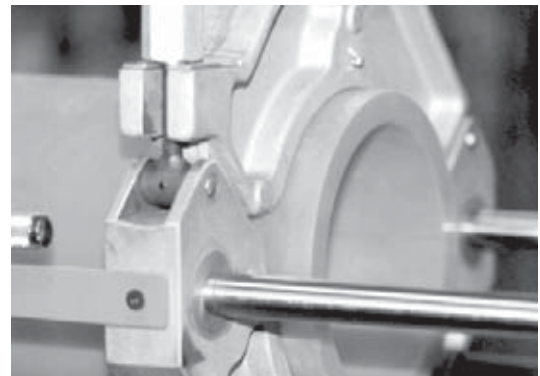

PH00306-9-12-940

TX00383-9-15-94

Install Next Piece of Pipe

Insert a new piece of pipe in movable jaws and repeat all previous procedures.

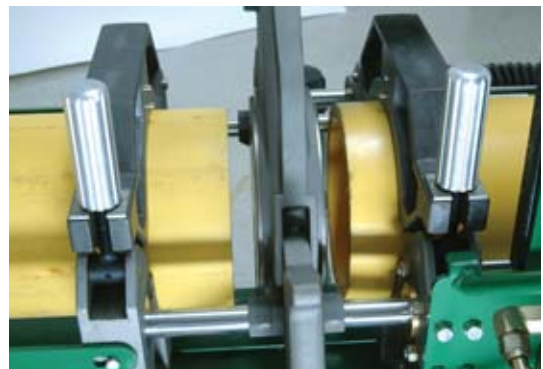

PH02497-07-08-03

TX00384-10-12-95

Special Operations - In Ditch

Remove Facer From Machine

Loosen facer locking bolts.

Lift facer out of the carriage and set on cardboard or wood blocks off of the ground.

Remove rear guide rod bracket.

Attach rear guide rod bracket in the position shown.



PH00383-9-15-94



PH01981-11-15-01

TX02217-09-18-03



PH01980-11-15-01

Remove Carriage Assembly from the Chassis



This equipment is not explosion proof. Operation of this equipment in an explosive atmosphere without necessary safety precautions will result in serious injury or death. See safety section.

The carriage can be easily removed from the machine for fusing pipe on the ground or in the ditch. For especially tight conditions it is also possible to remove the outer fixed jaws and skid. The facer can be removed from the pivot shaft and used manually.

Remove Pin.

Attach lifting sling to the lifting point on the opposite jaw brace and the manifold bracket, then lift the carriage assembly.



PH02501-07-08-03



PH02499-07-08-03

TX01876-05-09-14



PH02500-07-08-03

Special Operations - In Ditch

Outrigger

The outrigger is an arm that is retractable and adds support to the carriage assembly when opening the jaws and pivoting the facer away from the carriage.

To extend or retract the outrigger, press the locking button near the base of the outrigger and push or pull the arm until the button snaps to the locked position.

NOTICE: Never use the outrigger to lift or move the carriage.



TX02304-04-29-04

Special Operations - In Ditch

Remove 3-Jaw Assembly from the Carriage

Remove braces from inner fixed jaw.



PH02504-07:10-03

Remove the four bolts holding carriage assembly to the chassis with the wrench provided.



PH02503-07:10-03

Attach lifting strap as shown and lift the carriage assembly.



PH02502-07:10-03



PH02506-07:10-03



PH02505-07:10-03

Special Operations - In Ditch

Manual Facer Operation

Lift as shown.



Lock onto back guide rod, then latch on front guide rod.

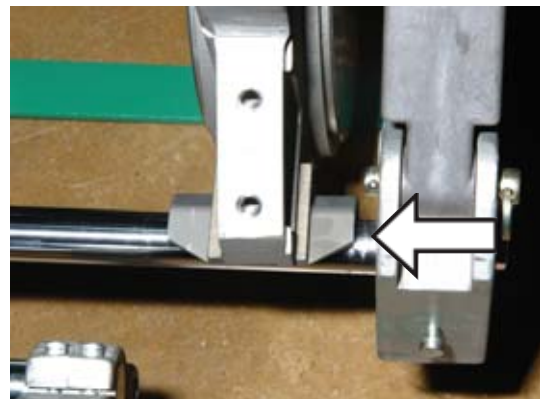

TX01887-11-15-00

Removing Top Jaws

If the carriage is going to be hand carried, or if the carriage needs to be hoisted and slid underneath the pipe, the top jaws need to be removed.

Loosen all clamp knobs. Take out the detent pins securing the top jaws and remove the jaws.

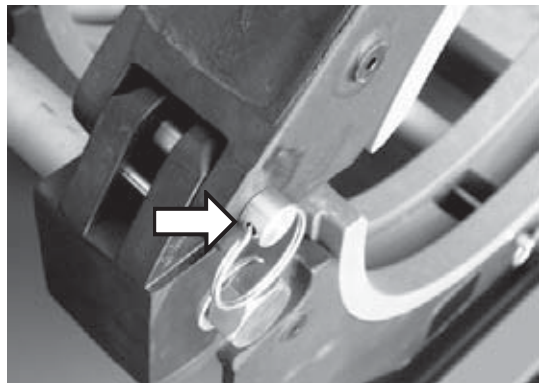

TX01479-2:26-98

Special Operations - In Ditch

Lower 3-Jaw or 4-Jaw Carriage into Ditch

Use all 4 jaws whenever possible. The three jaw unit should be used only when space is not available for the entire carriage, such as fusing onto a tee, an ell or doing saddle fusion.

4-Jaw

Attach lifting sling to the manifold bracket and the far side lift point.

Lift carriage assembly and lower into ditch.

3-Jaw

Attach lifting strap to the manifold bracket.

Lift carriage assembly and lower into ditch.

TX01864-4-22-10



PH02510-07-10-03



PH04147-4-22-10

Lower Carriage Into Ditch

Remove top jaws from unit by pulling ball lock pins.

Attach lifting sling to lifting point.

Lift carriage assembly up and lower into ditch.

TX00448-9-16-94



PH02500-07-10-03

Special Operations - In Ditch

Clamp Carriage Assembly to Pipe

Position carriage assembly on side of the pipe. Lift pipe and slide carriage assembly under pipe.

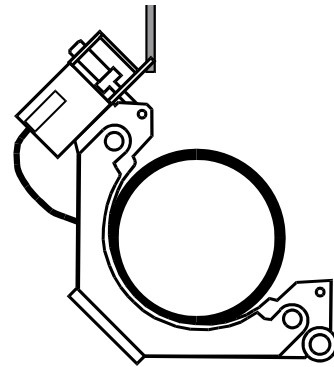

CD00193b-2:19-96

Rotate carriage assembly around to a normal upright position.

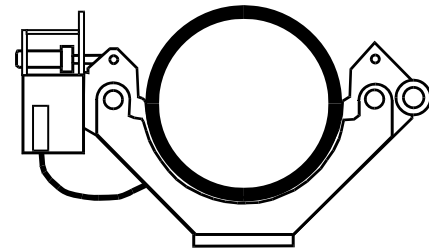

CD00194b-2:19-96

Attach the top jaws and loosely clamp around pipe.

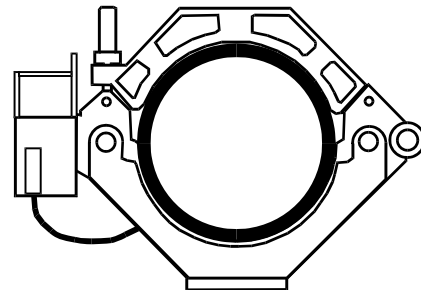

CD00195a-2:19-96

TX00879-2:19-96

Special Operations - In Ditch

Make Fusion Joint

Refer to the "Butt Fusion Procedure" for operating instructions.
After facing operation, remove the facer from ditch.

TX00450-9-16-94

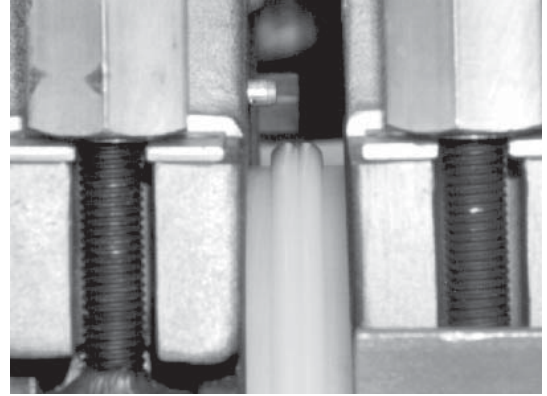

PH00363-9-12-94

Remove Carriage Assembly from Ditch

Loosen clamp knobs and remove top jaws.
Rotate carriage assembly from under the pipe.
IMPORTANT: Always rotate unit with valve system facing up to protect against damage.
Attach sling to lifting point(s).
Lift carriage assembly from ditch.

TX00451-9-16-94

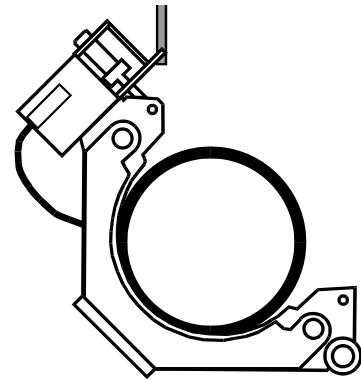

CD00193b-9-29-00

Reassemble Fusion Machine

Install carriage assembly to the chassis and connect carriage hoses.
Lift facer into position and bolt to facer mount. Do not tighten. Pivot facer down and bring jaws inward against the facer to establish facer position. Open jaws away from facer and pivot facer out. Tighten the facer mounting bolts.
Connect facer hoses.
Replace top jaws.

TX02136-07-11-03



PH01907-11-15-00

Special Operations - Saddle Fusion Procedure

Saddle Fusion Procedure

The combination unit is capable of saddle fusing up to an 8" (200 mm) branch on any size main.



PH00406-9-21-94

TX00454-9-22-94

Install Heater Adapters

⚠ DANGER Heater is not explosion proof. Operation of heater in an explosive atmosphere without necessary safety precautions will result in serious injury and death.

If operating in an explosive atmosphere, heater should be brought up to temperature in a safe environment, then unplugged before entering the explosive atmosphere for fusion.

Select appropriate heater and sidewall fusion heater adapters. Clean heater surfaces and adapter surfaces. Attach the adapters to the heater.

Place heater in insulated heater blanket.

Plug heater into a proper power source.

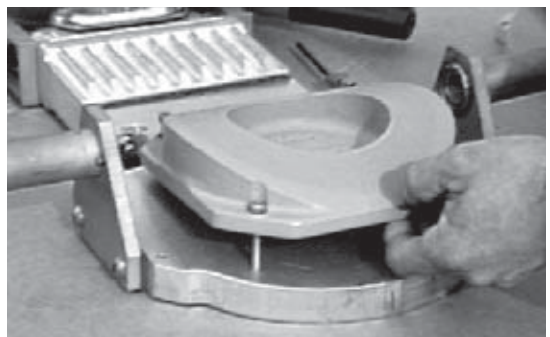

PH00416-11-1-94



PH00418-11-1-94

TX00455-04-07-14

Assure Saddle Will Fit

For branch saddles, a nipple long enough to extend through both movable jaws should be fused to the fitting using standard butt fusion procedures.

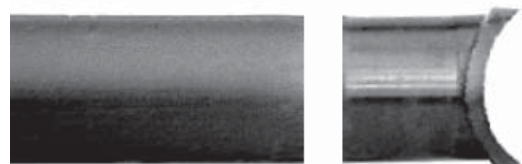

PH00423-11-1-94

TX00456-9-15-94

Special Operations - Saddle Fusion Procedure

Install Clamping Inserts

Select and install appropriate clamping inserts in the movable jaw(s).

TX00457-9-16-94

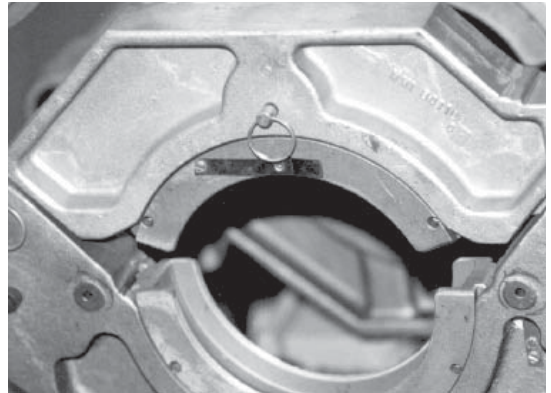

PH00304-9-23-93

Attach Carriage Assembly to Main

Place the machine on the main.

Place a line bolster on main opposite the carriage assembly if required.

Position the tailstock chains around the main and lock into the chain hooks.

Tighten the machine onto the main using the tailstock clamp knobs.

NOTICE: For main pipe sizes larger than 18", it may be necessary to remove the carriage from the chassis.

TX02137-07-11-03

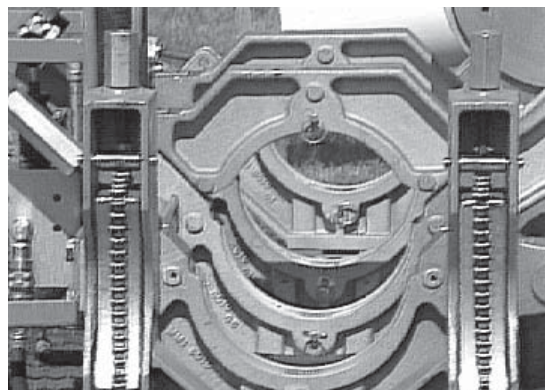

PH00387-9-21-94

Set Hydraulic Pressure

Check hydraulic pressure. Shift the selector valve to the center position to set the pressure for heating (if heating pressure differs from fusion pressure). With the selector valve in the down position, the fusion pressure can be set.

Consult the pipe manufacturer for proper pressures.

TX00459-9-16-94

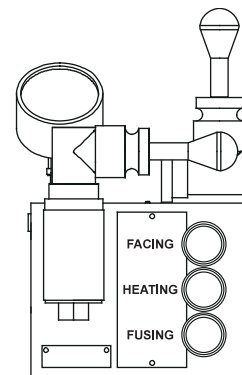

CD001388-9-12-94

Clean Surfaces

Use 50 or 60 grit utility cloth to clean and rough the main to expose fresh material.

Rough the base of the fitting unless the manufacturer specifies otherwise.

TX00460-9-16-94

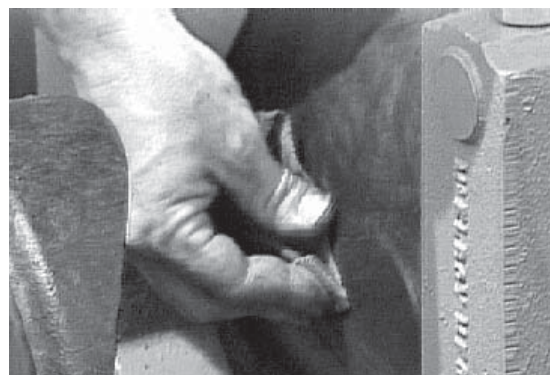

PH00400-9-21-94

Special Operations - Saddle Fusion Procedure

Clamp Fitting

Position the fitting, and bolster if required, loosely in the movable jaw(s). Move the carriage to the right to properly position the fitting on the main. Tighten the clamp knobs.

Be sure to allow enough travel for the melt pattern and fusion to occur (3/4" min.).

TX00461-9-15-94

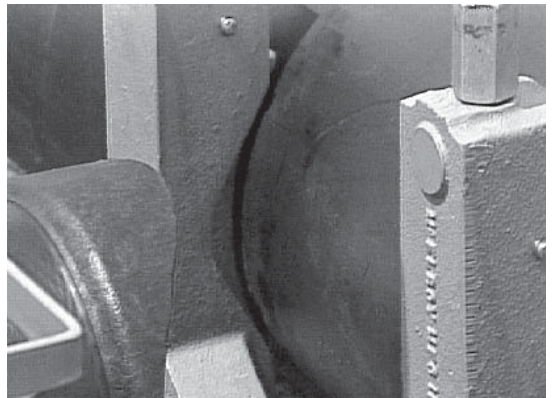

PH00399-9-21-94

Test for Slippage

Bring the fitting against the main under full fusion pressure to insure that no slippage or movement of the main or fitting occurs.

TX00462-9-14-94

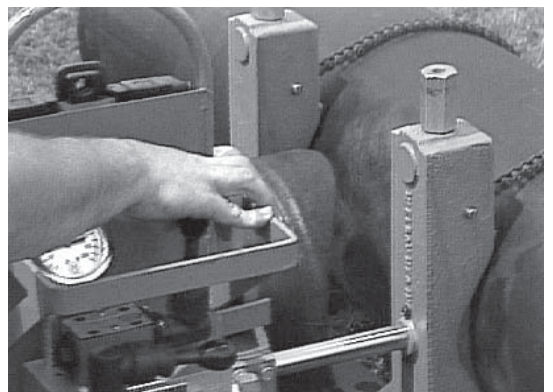

PH00390-9-21-94

Prepare Heater



Heater is not explosion proof. Operation of heater in an explosive atmosphere without necessary safety precautions will result in serious injury or death.

If operating in an explosive atmosphere, heater should be brought up to temperature in a safe environment, then unplugged before entering the explosive atmosphere for fusion.

Use a clean non-synthetic cloth to clean the saddle fusion heater adapter surfaces.

Verify heater temperature by noting the reading on the dial thermometer.

Check the heater temperature and install heater between the fitting and main. Assure proper line-up.

TX00463-05-09-14

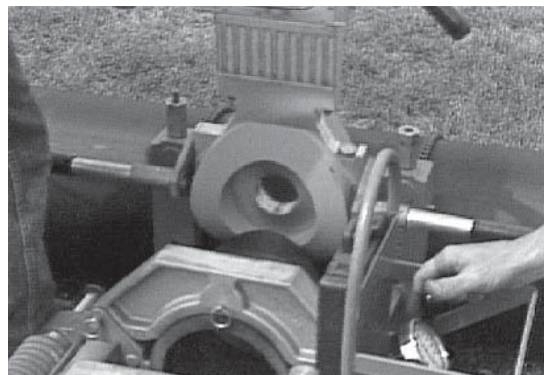

PH00389-9-21-94

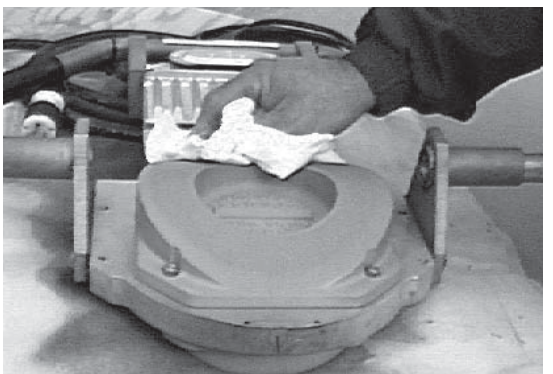

PH00417-11-1-94

Special Operations - Saddle Fusion Procedure

Heat Pipe and Fitting

Move selector valve to the center position, if pressure during the heat cycle differs from fusion pressure. Move the carriage to the right to bring the fitting in contact with the heater and the heater in contact with the main. The carriage control valve lever must be positioned in the right hand position to maintain pressure.

Establish proper melt pattern as specified by the material supplier.

TX00464-9-14-94

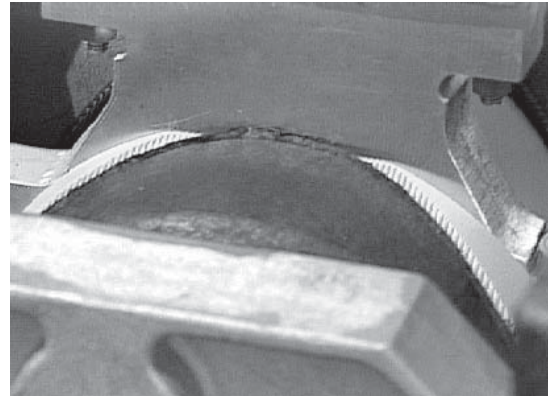

PH00402921-94

Remove Heater

Shift the carriage control valve to neutral and then the selector valve down to the fusion position. Move the carriage to the left just enough to remove the heater.

TX00465-9-14-94

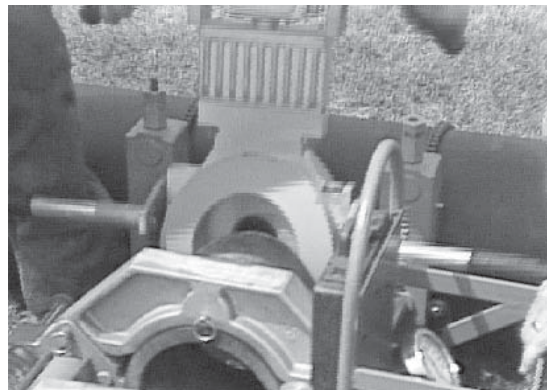

PH00404921-94

Fuse Fitting to Pipe

Remove the heater with a snap action and quickly inspect the melt pattern. Quickly move the carriage to the right bringing the fitting and main together under the pipe manufacturer's recommended pressure.

TX00466-9-14-94



PH00403921-94

Allow Joint to Cool

Allow the joint to cool under pressure as specified by the pipe manufacturer. To maintain fusion pressure during cooling, the carriage control valve must be positioned in the right hand direction.

TX00467-9-14-94

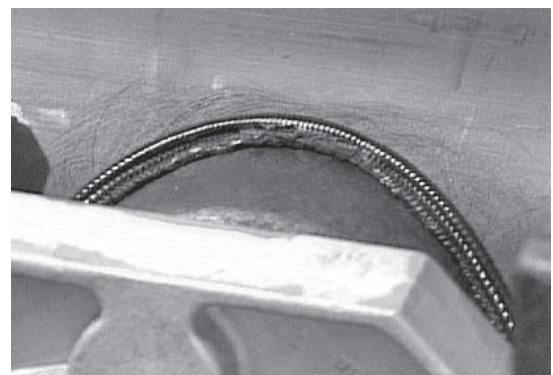

PH00405921-94

Special Operations - Lifting Fusion Machine

Lifting Safety

Follow all applicable federal, state, local, and industry specific regulations when lifting.

⚠ WARNING

Safety warnings:

1. Do not exceed rated load or lift loads greater than the rated load rating of the lifting device.
2. Do not operate a damaged or malfunctioning lifting device.
3. Do not lift persons.
4. Do not lift a suspended load over persons.
5. Do not leave a suspended load unattended.
6. Do not remove or obscure warning labels.
7. Read and understand the operator's manual before using the device.
8. Stay clear of the suspended load.
9. Lift loads only as high as necessary.
10. Do not alter or modify the lifting device.
11. Employ generally accepted safe lifting practices.
12. Do not shock or impact load the lifting device.
13. Inspect all lifting pins for damage.



SAFE1st-12-14-92

WR00014-3-8-93

Special Operations - Lifting Fusion Machine

Required Equipment

- Proper overhead rigging and equipment of adequate load rating to lift the fusion machine.
- One 24" piece of 6" or 8" Diameter SDR 11 pipe.
- One 28" piece of 6" or 8" Diameter SDR 11 pipe.
- Two Nylon lifting slings.

NOTICE: Slings are tagged for safe load limits. Do not overload. Proper lift slings are constructed of high-strength woven nylon with red fibers in the core that become exposed if the sling is cut or worn. If a red fiber is visible, immediately discard the sling, and replace with a new one.

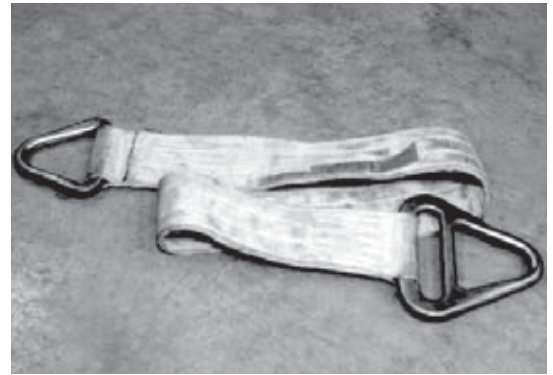

PH003285-19-94

TX02138-07-11-03

Install Pipe Pieces

When using 6" pipe install appropriate clamping inserts
Place the 24" long piece pipe into the movable jaws.
Place the 28" long piece pipe into the fixed jaws.
Securely tighten the clamp knobs so the jaws hold the pipe.

TX004079-16-94

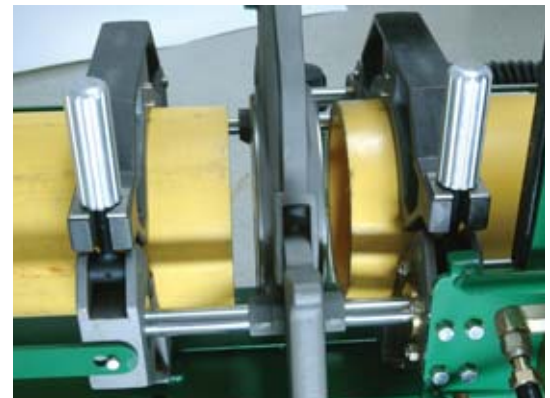

PH02497-07-11-03

Ready the Unit for Lifting

Pivot the Facer into the facing position.
Bring the Jaws together so the pipe ends touch the facer.
Disconnect fusion unit from all power sources.
Insert the detent pins that secure the pipe lift and tow bar into their storage position.

TX00408-10-7-93

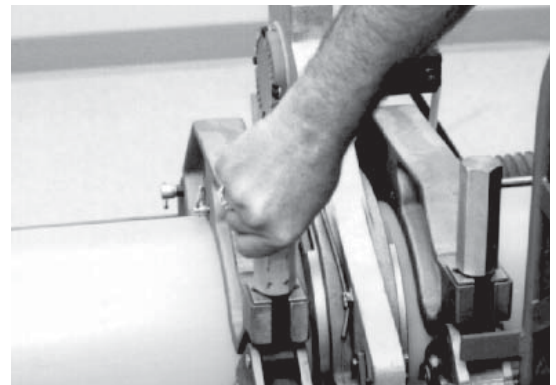

PH003559-12-94

Special Operations - Lifting Fusion Machine

Attach Slings

Loop the lifting slings around the pieces of pipe.
Gather the sling ends together, and insert them into the hook that is attached to proper lifting equipment.



PH00329-5-19-94

TX00409-09-16-94

Lift Equipment

Using proper overhead rigging and equipment of adequate load rating lift the fusion unit.



PH02572-09-16-03

TX02139-07-11-03

Maintenance

Preventative Maintenance

To insure optimum performance, the machine must be kept clean and well maintained.

With reasonable care, this machine will give years of service. Therefore, it is important that a regular schedule of preventive maintenance be kept.

Store machine inside, out of the weather, whenever possible.

TX00428-8-10-95

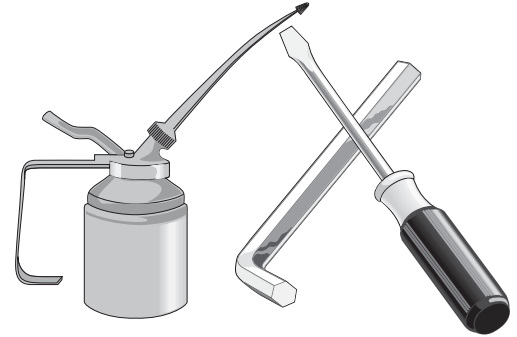

CD00142-11-2-94

Washing the Machine

The machine should be cleaned, as needed with a soap and water wash.

Do not pressure wash.

TX00429-04-28-14



PH00432-11-1-94

Check Hydraulic Fluid

The hydraulic fluid level should be checked daily.

If hydraulic fluid is not visible in the sight gauge, fluid must be added.

Refer to the "Hydraulic Fluids" section of this manual for hydraulic fluid recommendations.

If fluid is not visible in the sight gauge, fill reservoir until fluid is visible in the sight gauge. Do not overfill reservoir as the fluid will expand as it heats up.

Never allow dirt, water or other foreign matter to enter the tank.

Use only clean fluid from an unopened container.

TX00430-04-28-14



PH02483-07-11-03

Change Hydraulic Fluid and Filter

The hydraulic fluid and filter should be replaced when the filter pressure gauge indicates "service filter".

Fluid should also be changed as extreme weather conditions dictate.

Refer to the "Hydraulic Fluids" section of this manual for hydraulic fluid recommendations.

TX02140-04-28-14



PH02604-09-18-03

Maintenance

Check Gauge

Gauge should be checked daily.
The gauge should read zero when the unit is not running.
Damaged gauges should be replaced.

TX02291-3-8-04



Clean Jaws and Inserts

To prevent slippage and insure proper alignment, the jaws and inserts must be clean.
Clean the jaws and inserts of any dirt or residual material using a stiff-bristled brush.

TX00433-9-15-94



Clean Thrust Bearings

The thrust bearings located in the clamp knobs must turn freely.
Wash the clamp knob bearing assembly with a solvent, and then lubricate with 30W or lighter oil.

TX00434-9-13-94

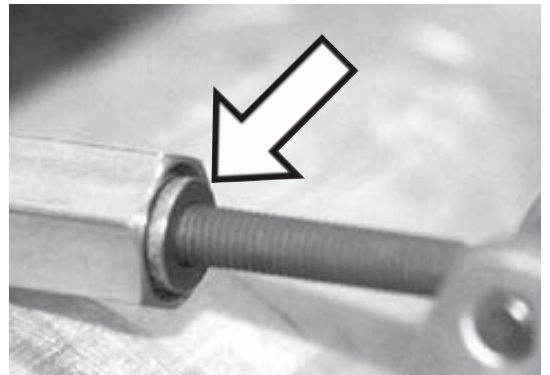

Clean Eyebolt Threads

Keep the clamp knob eyebolt threads brushed clean.

TX00435-9-13-94

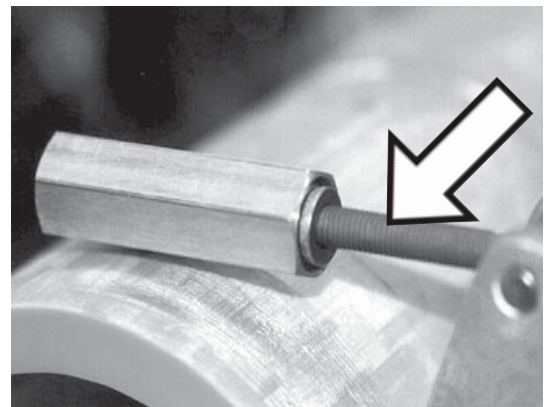

Maintenance

Clean the Clamping Chains

On the combination unit clean the side fusion chains as needed. Clean using a stiff-bristled brush and oil generously. Wipe away any excess oil.

TX00436-9-13-94

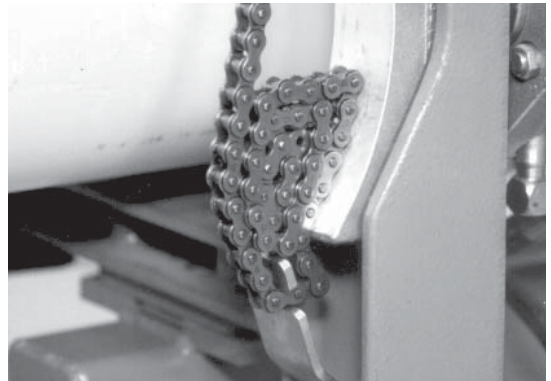

PH00378-9-14-94

Fasteners Must Be Tight

Check all nuts, bolts, and snap rings to make certain they are secure and in place.

TX00437-9-13-94



PH00433-11-1-94

Facer

The facer should be lubricated annually.

TX00438-9-15-94



PH02491-07-11-03

Facer Blades

Blades bolt directly to the blade holder and should be inspected for damage and sharpness.

Dull or chipped blades must be replaced.

NOTICE: Never extend the blade beyond the inner or outer circumference of the facer.

TX02475-3-29-05



PH02491-07-11-03

Maintenance

Clean Heater Surfaces

The heater faces must be kept clean and free of any plastic build up or contamination.

Before each fusion joint the heater surfaces must be wiped with a clean, non-synthetic cloth.

NOTICE: Do not use an abrasive pad or steel wool. Use a non-synthetic cloth that won't damage surfaces.

TX00440-8-14-08



PH004929-6-5-13

Bleeding Air From Hydraulic System

The two carriage cylinders have air bleed screws and must be bled if the system ever runs low on oil or leaks air on inlet side of pump. Air in the system is indicated when carriage movement becomes jerky and erratic. To bleed the system, proceed as follows:

Remove upper jaws and clamping eye bolts from the two movable clamp jaws to expose the bleed plugs recessed in top of the lower jaws.

Tilt machine so the fixed jaw end is higher than the opposite end.

Shift the directional control and move the carriage to the fixed jaw end. Adjust the pressure to approximately 50-100 psi before proceeding.

Loosen the bleed plug on one cylinder next to the fixed jaw.

Hold pressure on the cylinder until no air is indicated and quickly tighten the plug.

Repeat this operation on the opposite cylinder.

Tilt the machine so the opposite end is higher than the fixed jaw end. Move the carriage to the end opposite the fixed jaw and repeat the above procedure on the this end of the cylinders.

TX00427-9-15-94

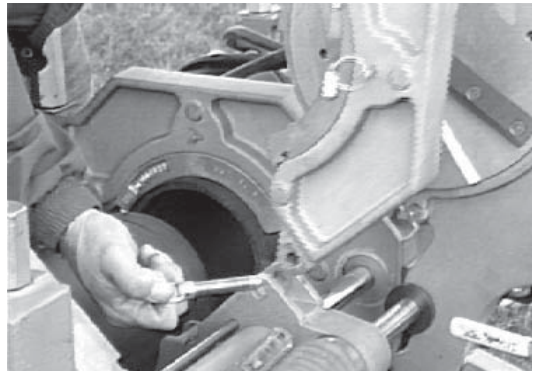

PH00435-11-1-94

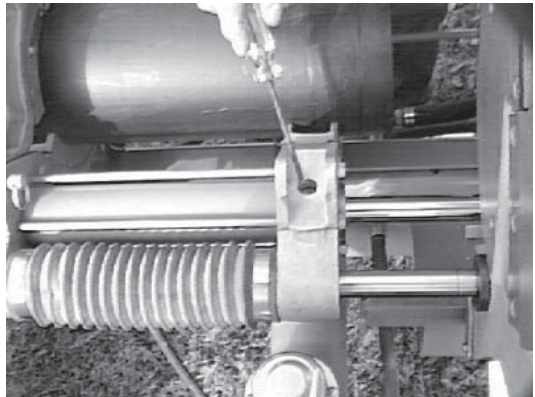

PH00435-11-1-94

Maintenance

Installing Butt Fusion Heater Plates

The heater body of this assembly is not coated. Coated butt fusion heater plates are available for all butt fusion applications.

Butt fusion heater plates are installed with eight Stainless Steel Cap Screws.

Care should be taken to assure that the butt fusion heater plates are seated on the heater body, and that there is no foreign matter trapped between these surfaces.

IMPORTANT: Do not over tighten the bolts.

The surface of the butt fusion heater plates are coated with an antistick coating.

TX02311-07-30-04



PH04930-6-5-13

Adjusting Heater Temperature

Turn knob to desired temperature. Measure the heater surface temperature with a pyrometer. Any variance must be corrected to the pyrometer reading.

Loosen setscrew in the knob. Turn knob to point to the same temperature as the pyrometer. Tighten setscrew in the knob.

Turn knob to desired temperature. Allow heater to stabilize at the new temperature (5 to 10 minutes) after adjusting.

The thermometer on the heater body indicates internal temperature and should be used as a reference only.

TX02009-3-13-02



PH02313-4-24-02

Heater Indicator Light

The heater has a green indicator light which will flash on and off. This indicates that the controller is operating normally. If the green indicator is not flashing then the controller may not be operating properly. If this occurs, disconnect power and have the heater repaired by an McElroy Authorized Service Center.

The heater has a red indicator light on the handle at the bottom of the temperature scale. When the heater is plugged in and preheating the red light glows steadily until the set temperature is reached. The red light then goes off and on as the heater maintains temperature.

If the heater is not operating properly, the control will attempt to turn the heater off and the red indicator light will flash rapidly. If this occurs, disconnect the power and take it to a McElroy Authorized Service Center for repair.

TX04036-4-12-10



PH02314-4-24-02

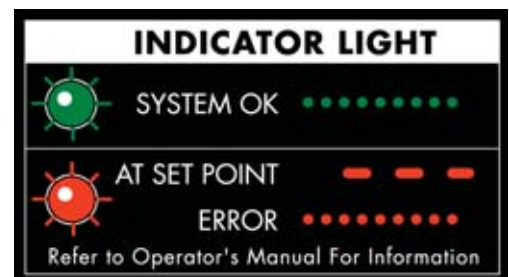

PH02571-09-16-03

Maintenance Checklist

Fusion Machine Checklist

Item to Check	Satisfactory	Needs Repair	Repair Comments
UNIT			
Machine is clean			
All pins and snap rings are in place			
All nuts and bolts are tight			
All placards and handles are in place			
All clamp knobs turn freely			
Cords and plugs are in good condition			
All hardware is on the basic machine			
Hydraulic fluid reservoir is filled to correct level			
Machine is free of hydraulic leaks			
Hydraulic gauge reads correctly			
Brake functions properly			
Tire pressure is correct			
Jaws are properly aligned			
Facer pivot operates properly			
Facer operates smoothly			
Face-off is square			
Inserts fit and pin properly			
Primary pump pressure can be adjusted from 500 psi to 1200 psi			
Input voltage to machine - (108 - 132 VAC)			
Carriage and Selector Valves operate smoothly			
Pressure Reducing Valves operate in their range			
Filter gauge reads correctly			
HEATER			
Cord and plug are in good condition			
Heater surface is clean and in good condition			
Thermometer is in good working order			
Surface temperature checked with pyrometer			
Check receptacles for damage			

Determining Fusion Pressure

Variable Definitions

- O.D. = Outside Diameter
- t = Wall Thickness
- Π = 3.1416
- SDR = Standard Dimensional Ratio
- IFP = Manufacturer's Recommended Interfacial Pressure
- TEPA = Total Effective Piston Area

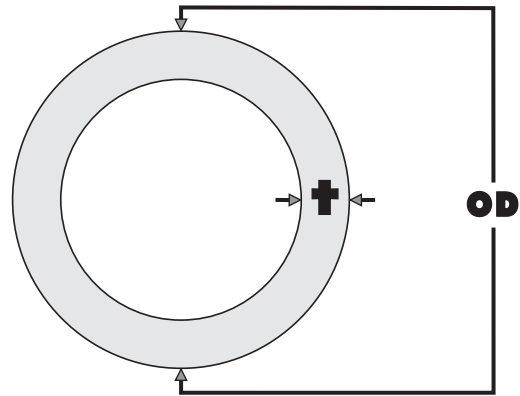

Formulas

$$t = \frac{\text{O.D.}}{\text{SDR}}$$

$$\text{AREA} = (\text{O.D.} - t) \times t \times \Pi$$

$$\text{FORCE} = \text{AREA} \times \text{IFP}$$

$$\text{GAUGE PRESSURE} = \frac{(\text{O.D.} - t) \times t \times \Pi \times \text{IFP}}{\text{TEPA}} + \text{DRAG}$$

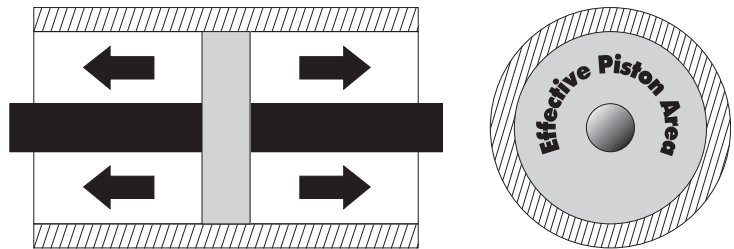

Example

Pipe Size = 8" IPS

O.D. of Pipe = 8.625

DRAG = as measured in PSI (for this example use 30 PSI)

SDR of Pipe = 11

Recommended Interfacial Pressure = 75 PSI

Using a Model 28 Fusion Unit

$$t = \frac{\text{O.D.}}{\text{SDR}} = \frac{8.625}{11} = 0.784$$

TEPA = 4.710 (From Table)

$$\text{GAUGE PRESSURE} = \frac{(\text{O.D.} - t) \times t \times \Pi \times \text{IFP}}{\text{TEPA}} + \text{DRAG}$$

$$\text{GAUGE PRESSURE} = \frac{(8.625 - .784) \times .784 \times 3.1416 \times 75}{4.710} + 30 \text{ PSI} = 338 \text{ PSI}$$

Total Effective Piston Areas

Fusion Model	High Force (Standard)	Medium Force (High Velocity)	Low Force (Extra High Velocity)
28/250	4.71	-	1.66
412	11.78	6.01	3.14
618	11.78	6.01	3.14
824	29.44	15.32	9.45
1236	29.44	15.32	9.45
1648	31.42	14.14	-
2065	31.42	-	-
1600	31.42	14.14	-

Determining Fusion Pressure - Sidewall

Variable Definitions

- O.D. = Outside Diameter of Base (not branch)
 t = Wall Thickness
 Π = 3.1416
 SDR = Standard Dimensional Ratio
 IFP = Manufacturer's Recommended Interfacial Pressure
 TEPA = Total Effective Piston Area

Formulas

$$t = \frac{\text{O.D.}}{\text{SDR}}$$

$$\text{AREA} = (\text{O.D.} - t) \times t \times \Pi$$

$$\text{FORCE} = \text{AREA} \times \text{IFP}$$

- IFP = 60 PSI for Bead-up
 0 PSI for Heat/Soak
 30 PSI for Saddle Fusion

ROUND BASE

$$\frac{(\text{O.D.} - t) \times t \times \Pi \times \text{IFP}}{\text{TEPA}}$$

RECTANGULAR BASE

$$\frac{[L \times W - (d \times d \times 0.7854)] \times \text{IFP}}{\text{TEPA}}$$

Example

O.D. of Base = 7.36"

t = 1.10"

DRAG = as measured in PSI (30 PSI for this example)

30 PSI for Saddle Fusion (must calculate for other IFP's also).

Using 28 Combination Unit and calculating the fusion pressure

$$\frac{(\text{O.D.} - t) \times t \times \Pi \times \text{IFP}}{\text{TEPA}} + \text{DRAG}$$

$$\frac{(7.36 - 1.10) \times 1.10 \times 3.14 \times 30}{4.71} + 30 \text{ PSI}$$

$$\frac{648.66}{4.71} + 30 \text{ PSI} = \mathbf{168 \text{ PSI Fusion Pressure}}$$

Using the same formula substitute the IFP with the IFP appropriate for the process and recalculate for each

Heat Soak Pressure for this example = **30 PSI**

Bead-up Pressure for this example = **306 PSI**

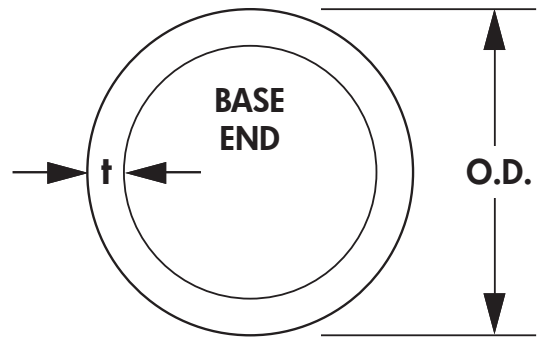

ROUND BASE

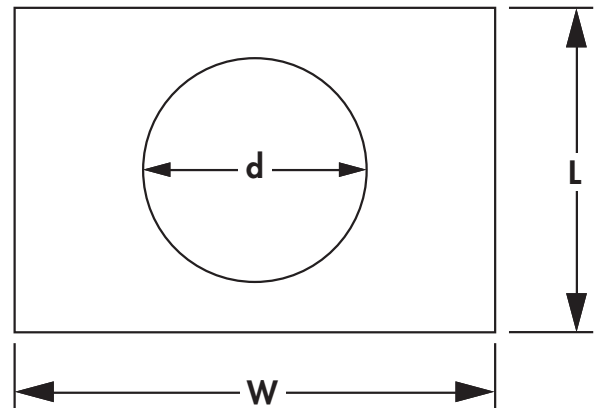

RECTANGULAR BASE

Total Effective Piston Areas

Fusion Model	High Force (Standard)	Medium Force (High Velocity)	Low Force Extra High Velocity
Sidewinder	1.00		
28 CU	4.71	-	1.66
28 EP Sidewall	-	-	1.66
18 Sidewall	11.80	-	-
36 Sidewall	11.00	-	-

Hydraulic Fluids

Hydraulic Fluids

The use of proper hydraulic fluid is mandatory to achieve maximum performance and machine life. Use a clean, high quality, anti-wear hydraulic fluid with a viscosity index (VI) of 135 minimum. It should have a maximum viscosity of 500 cSt (2000 SSU) at startup (ambient temperature) and a minimum viscosity of 13 cSt (65 SSU) at the maximum fluid temperature (generally 80°F above ambient). Using hydraulic fluids that do not meet these criteria may cause poor operation and/or damage to the hydraulic components.

The following table specifies the fluid temperature at various viscosities. Temperature rise of the hydraulic fluid can vary from 30° F to about 80° F over the ambient temperature depending on the pressure setting, age of the pump, wind, etc. Mobil Unavis N46 hydraulic fluid is installed at our factory. The advantage of this fluid is a wider temperature range, however, this fluid should not be used for continuous operation below 24°F.

NOTE: The Mobil DTE 10 Excel series replaced the DTE 10M Series. The Exxon Unavis N series are now Mobil Unavis N.

Hydraulic Fluids Characteristics																	
Manufacturer	Fluid Name	cSt 100F	cSt 210F	V.I.	-20F	-10F	0F	10F	30F	50F	70F	90F	110F	130F	150F	Range °F	Range °C
Mobil	10 Excel 15	15.8	4.1	168	*****	*****	*****	*****	*****	*****	*****	*****	*****	*****	*****	-16 - 113	-27 - 45
	10 Excel 32	32.7	6.6	164					*****	*****	*****	*****	*****	*****	*****	12 - 154	-11 - 68
	10 Excel 46	45.6	8.5	164						*****	*****	*****	*****	*****	*****	23-173	-5 - 78
	10 Excel 68	68.4	11.2	156						*****	*****	*****	*****	*****	*****	37-196	3 - 91
	Unavis N-32	34.9	6.9	164					*****	*****	*****	*****	*****	*****	*****	12-150	-11 - 66
	Unavis N-46	46	8.5	163					*****	*****	*****	*****	*****	*****	*****	24-166	-4 - 74
	Unavis N-68	73.8	12.1	160						*****	*****	*****	*****	*****	*****	39-193	4 - 89

TX03082226-14

NOTE: This chart is based on pump manufacturer recommendations of 13 to 500 cSt.

NOTE: Temperatures shown are fluid temperatures. – NOT ambient temperatures.

Specifications

28 Fusion Machine Dimensions:

Width: 38" (965mm)
Length: 65.5" (1664mm)
Height: 49.5" (1257mm)

Fusion Machine with Facer: 575 lbs. (261 Kg)
4 Jaw Carriage Assembly without Facer: 221 lbs. (100 Kg)
3-Jaw Carriage Assembly without Facer: 142 lbs. (64 Kg)
Facer: 44 lbs. (19.9 Kg)
Heater: 21 lbs (9.5 Kg)

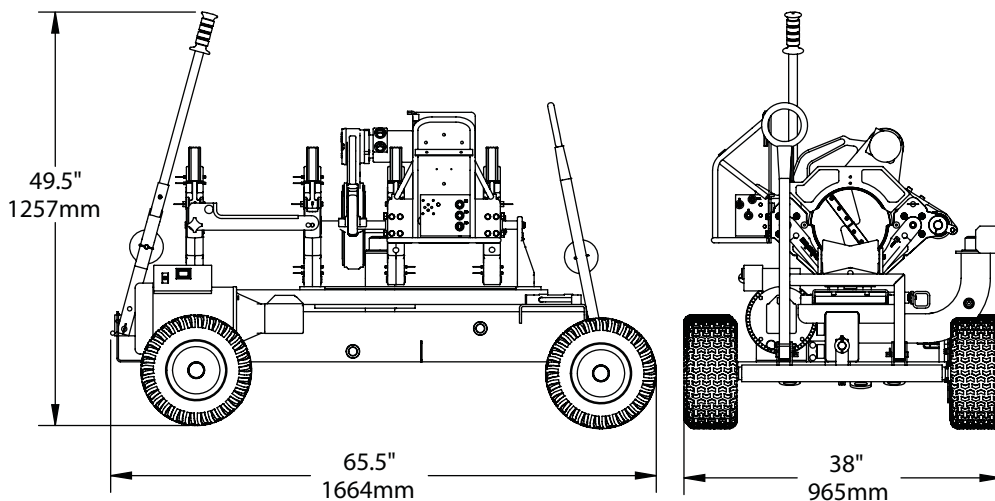

Specifications:

Design Pressure: 900 psi (62 BAR) max. (capable of more with modification)
Reservoir Capacity: 5 gallons (18.92 Liters)
Hydraulic Fluid: Refer to Hydraulic Fluids Section
Total effective piston area: 4.71 square inches (see cylinder label for other piston areas)
Heater Power: 3000 Watt
Sidewall Heater Power: 1750 Watt

Available in butt fusion or a combination of butt and saddle fusion configuration

Designed for connecting the McElroy Datalogger® unit .

Hydraulic facer for hazardous environments and reduced maintenance.

Other Features:

- Pipe lift located on front and back
- Thrust bearing clamp knobs
- Three mode manifold block
- High flotation tires
- Heater with butt fusion heater plates
- Quick change inserts for various pipe sizes
- Positive locking wheel brake

Specifications

250 Fusion Machine Dimensions:

Width: 38" (965mm)
Length: 65.5" (1664mm)
Height: 49.5" (1257mm)

Fusion Machine with Facer: 575 lbs. (261 Kg)
4-Jaw Carriage Assembly without Facer: 203 lbs. (92 Kg)
3-Jaw Carriage Assembly without Facer: 124 lbs. (56 Kg)
Facer: 44 lbs. (19.9 Kg)
Heater: 21 lbs (9.5 Kg)

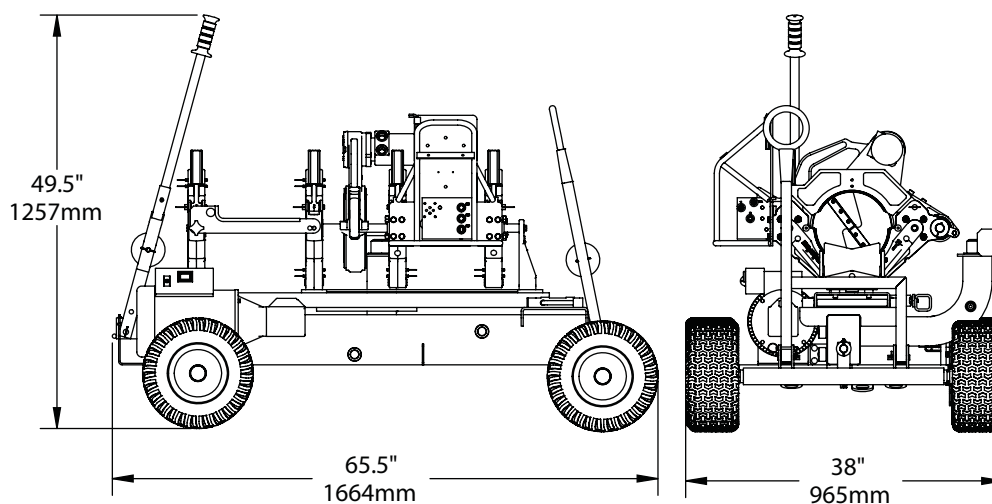

Specifications:

The 250 model fuses 2" IPS (63mm) minimum to 250mm maximum pipe.

Design Pressure:	900 psi (62 BAR) max. (capable of more with modification)
Reservoir Capacity:	5 gallons (18.92 Liters)
Hydraulic Fluid:	Refer to Hydraulic Fluids Section
Total effective piston area:	4.71 square inches (see cylinder label for other piston areas)
Heater Power:	3000 Watt
Sidewall Heater Power:	1750 Watt

Available in butt fusion or a combination of butt and saddle fusion configuration

Designed for connecting the McElroy Datalogger® unit .

Other Features:

- Pipe lift located on front and back
- Thrust bearing clamp knobs
- Three mode manifold block
- High flotation tires
- Heater with butt fusion heater plates
- Quick change inserts for various pipe sizes
- Positive locking wheel brake

Specifications

Generator Sizing Form

Complete this form and provide a copy to your generator supplier. This information will enable your generator supplier to correctly size a generator for your application.

Motor: 1 - 1/2 Horsepower

Motor Code Letter: _____ (from motor nameplate should be J or K)

Motor Voltage: _____ (120 or 220 VAC)

Motor Phases: 1

Motor Frequency: _____ (50 or 60 Hz)

Heater Wattage Rating: _____ Watts resistive

Heater Voltage: _____ (120 or 220 VAC)

Operational Altitude Range: _____ to _____

Ambient Temperature Range: _____ to _____

Duty Cycle: Standby (Not continuous 24 hours/day)

Allowable Voltage Dip: 20%

Allowable Frequency Dip: 5%

Starting Load Application: Simultaneous turn-on of both motor and heater.

Running Load: Motor continuous, heater cycling on and off at approximately 5 minute intervals.

Fuel: _____ (Gasoline or Diesel)

Special requirements for customer application: _____

About this manual . . .

McElroy Manufacturing continually strives to give customers the best quality products available. This manual is printed with materials made for durable applications and harsh environments.

This manual is waterproof, tear resistant, grease resistant, abrasion resistant and the bonding quality of the printing ensures a readable, durable product.

The material does not contain any cellulose based materials and does not contribute to the harvesting of our forests, or ozone-depleting constituents. This manual can be safely disposed of in a landfill and will not leach into ground water.

TX001660-8-19-99



P.O. Box 580550 Tulsa, Oklahoma 74158-0550, USA

www.mcelroy.com